

Experts in food distribution

SYSTEM KOMPETENZ

VON
SELTMANN WEIDEN



Seltmann
Weiden

SYSTEM



SYSTEM-KOMPETENZ von SELTMANN WEIDEN

SELTMANN WEIDEN. Wir produzieren in Deutschland ...



SELTMANN WEIDEN –

Expertise that spans generations.

KOMPETENZ SEIT VIELEN JAHRZEHNTEEN.



SELTMANN WEIDEN

Im Jahre 1910 gegründet hat sich die Porzellanfabrik **SELTMANN WEIDEN** durch Übernahme mehrerer Porzellanfabriken und Manufakturen zur **Unternehmensgruppe SELTMANN** entwickelt, die bis heute als Familienunternehmen geführt wird.

Porzellanfabrik SELTMANN WEIDEN was founded in 1910 through the takeover of several porcelain factories and manufacturers, which developed into the SELTMANN company group and which is still managed as a family-run company.

HOCH SPEZIALISIERT

SELTMANN WEIDEN hat sich im Laufe der Jahre zum **Porzellan-Spezialisten** in den Bereichen Haushalt, Incentives, Hotellerie / Gastronomie und der **Sozialgastronomie / Gemeinschaftsverpflegung** entwickelt. Insbesondere die Entwicklung von Porzellan-Serien im Bereich der Sozialgastronomie für die verschiedenen thermostatischen Systeme, Tablett-Systeme und »Out of House«-Lösungen wurde in den letzten Jahrzehnten verstärkt.

HIGHLY SPECIALISED

Over the years, SELTMANN WEIDEN has developed into the porcelain specialists in the areas of households, incentives, hotels / restaurants and institutional food services / communal catering. Tray systems and »out of house« solutions were enhanced over the last few decades, especially in the development of porcelain series in the area of institutional food services for different thermostatic systems.



CHRISTIAN SELTMANN, PORZELLANFABRIK WEIDEN (OBERPFALZ)



SELMANN WEIDEN – marktnah – umweltgerecht und ausschließlich in Deutschland produziert.



SELMANN WEIDEN – market-focused – produced exclusively and ecologically in Germany

IHR PARTNER VOR ORT ...

Know-how aus der Marktnähe, schnelle Lieferzeit, Ansprechpartner »vor Ort« und einen »sichtbaren« Handelspartner. Dem Kosten-Aspekt hält SELTMANN eine besonders lange Nachkaufmöglichkeit entgegen ...

YOUR LOCAL PARTNER ...

Know-how from market proximity, fast delivery times, »local« contact and a visible trading partner. SELTMANN counters the cost aspect with an especially long-term supply of products ...



Bei SELTMANN WEIDEN hat die Fertigung nach strengsten Umwelt-Kriterien und Gesundheits-Richtlinien seit jeher eine vorrangige Bedeutung.

At SELTMANN WEIDEN, production in accordance with strict environmental criteria and health guidelines has always been a top priority.

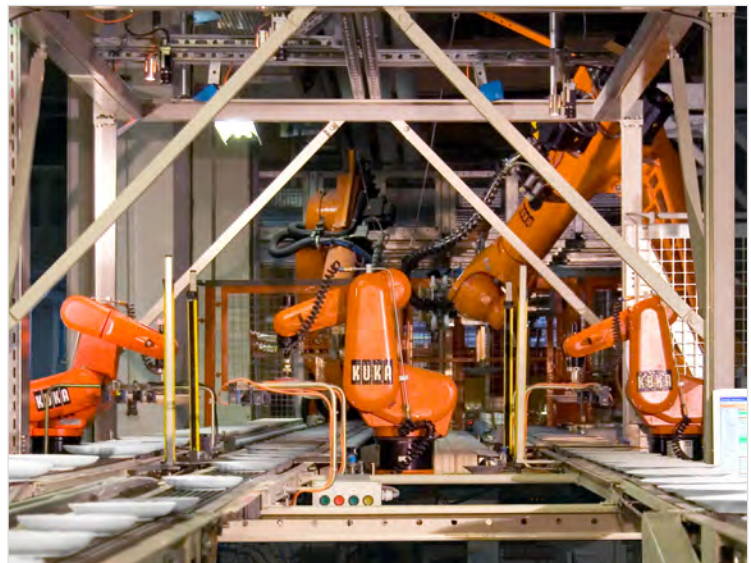

Die SELTMANN-Gruppe hält – als einer von wenigen Porzellanherstellern – sämtliche Produktionsstandorte in Deutschland!

The SELTMANN Group – as one of only a few porcelain manufacturers to do so - keeps all of its production facilities in Germany!





02 ÜBER SELTMANN WEIDEN *the company*

08 QUALITÄTSMERKMALE *quality features*

10 SYSTEMBERATUNG *system advice*

12 SYSTEME *systems*

PASSIVE Systeme *passive systems*

12 Tablettssysteme *tray systems*

24 PN – Porzellan-Norm *PN – porcelain standard*

AKTIVE Systeme *active systems*

28 Umluft *circulating air*

36 Kontaktwärme *contact heating*

46 Induktion *induction*

56 **SONDER Systeme** *special systems*

60 **GROSSGEBINDE** *regeneration of food in bulk*

66 **AUSSER HAUS Systeme** *out-of-house systems*

68 DEKORE & VIGNETTEN *decorations & logos*

72 ARTIKEL nach V-NUMMERN
items listed by V-number

ARTIKEL-Verzeichnis *item list*

76 Porzellan *porcelain*

110 Kunststoffdeckel *plastic lids*

128 VERTRETUNGEN & ANSPRECHPARTNER
contact persons & agencies

Seltmann
Weiden
Bavaria
Made in Germany



MIT DEM RICHTIGEN SYSTEM –
DER GEMEINSCHAFT
ZUM WOHLER!

*Benefiting the community with the
right system!*



DIE GEMEINSCHAFTSVERPFLEGUNG

Catering



Egal, ob noch ganz jung, heranwachsend-jugendlich, gefühlt jung, nicht mehr ganz so jung, ein Leben lang jung geblieben – oder in besonderen Lebens-Situationen.

Egal, ob in der Kindertagesstätte, der Schule, der Mensa, der Unternehmenskantine, dem Krankenhaus oder Pflegeheim – jede Lebens-Situation trägt ihre eigene außerordentliche Bedeutung in sich.

Whether you're still very young, adolescent, you feel young, are no longer quite so young, are young at heart – or in special life circumstances. Whether you're in kindergarten, school, the cafeteria, the company canteen, the hospital or a care home – each life situation is incredibly important in its own way.

Eine gute Ernährung hilft in bedeutendem Maße, einer »Unwucht« des Lebens zu begegnen oder sich dem kulinarischen Vergnügen hinzugeben. In jedem Fall gilt: »Du bist, was Du isst!«

A good diet really helps when combating an »imbalance« in life or indulging in culinary delights. As the saying goes: »you are what you eat!«

Um den Menschen in ihren ganz individuellen Lebens-Situationen eine gesunde Ernährung zu ermöglichen, haben wir mit den führenden Systemherstellern – den unterschiedlichen Anforderungs-Profilen entsprechend – Lösungen im Bereich der Gemeinschaftsverpflegung entwickelt.

We have developed solutions in the field of catering alongside leading system manufacturers – according to the various requirement profiles – in order to enable people to have a healthy diet whatever their personal life circumstances.



ALS PORZELLAN-SPEZIALIST IST FÜR UNS DIE KLAVIATUR DER PRODUKT-ANFORDERUNGEN – STANDARD!



STAPELFÄHIG
Stackable

Gut für ein besseres Handling: Alle Teile sind bei SELTMANN Varionorm-Systemporzellan raumökonomisch stapelbar.

*Good for easier handling:
All items of SELTMANN Varionorm porcelain are space savingly stockable.*

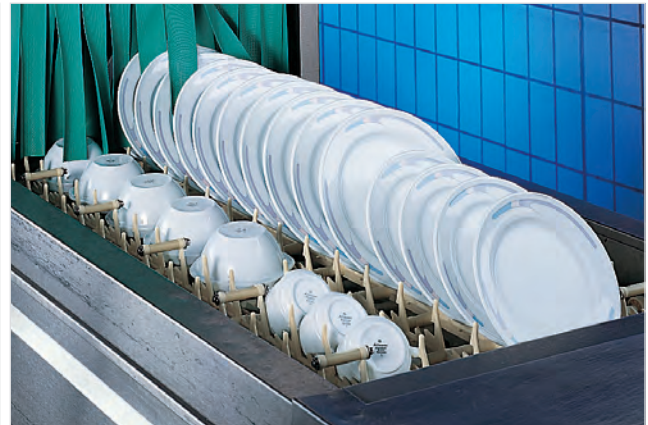

SPÜLMASCHINENFEST
Dishwasher-proof

Ansprechende und umfangreiche Dekorvariationen werden im SELTMANN Varionorm-Sortiment bei ca. 1.200° C in die Glasur eingebrannt. Das macht sie 100 % spülmaschinen- und mikrowellenfest.

For the SELTMANN Varionorm assortment, attractive and various decorations are burnt in glaze at approx. 2,192° F/1.200° C. This makes them 100% dishwasher and microwave proof.



KANTENBRUCHFEST
Break-proof edges

Porzellan rangiert in der Härteskala mit Mohs 7 gleich hinter dem Diamant. Es ist härter als z. B. Stahlbesteck, das deshalb der Glasur nichts anhaben kann. Verstärkte Kanten an den Rändern des Porzellans erhöhen zusätzlich seine Schlagfestigkeit.

In the hardness scale Varionorm porcelain with its value of Mohs 7, is next in hardness to the diamond. It is harder than steel cutlery which can therefore not damage the glaze. Reinforced edges of the porcelain rims make it even more break-proof.



FEUERFEST
Fire-proof

Durch eine Brenntemperatur von 1.450° C wird SELTMANN Varionorm-Systemporzellan absolut unempfindlich gegen alle Temperaturen auf und in GV-Kochstellen.

Due to a firing temperature of 2,642° F/1.450° C SELTMANN'S Varionorm porcelain is absolutely resistant to any temperature on and inside catering cookers.

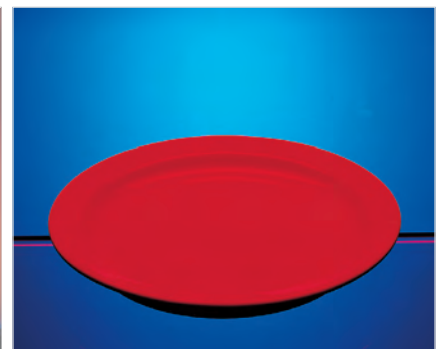

WÄRMESPEICHERND
Heat retaining

Varionorm-Systemporzellan von SELTMANN WEIDEN verfügt über hervorragende Wärmespeicherfähigkeit. Einmal aufgenommene Wärmeenergie gibt es nur sehr langsam wieder ab.

Varionorm porcelain by SELTMANN WEIDEN has an excellent heat storing capacity. Stored heat energy is only released slowly.

*As a porcelain specialist, the range of product requirements
is for us standard!*

HYGIENISCH

Hygienic

Die hochdichte, spiegelglatte Glasur-Oberfläche bietet Speiseresten oder Keimen keinerlei Angriffspunkte: Ein wertvolles Plus für die Hygiene, aber auch für die energiesparende Reinigung.

The extremely dense, smooth glaze surface does not offer any openings to leftovers or germs: a valuable plus for hygiene, but also for energy-saving cleansing.



UMWELTFREUNDLICH

Environmental

Die Porzellanmasse wird ohne chemische Zusätze aus den mehlfein zermahlenden Mineralien Kaolin, Feldspat und Quarz hergestellt. Gebrannt wird Porzellan ausschließlich mit umweltfreundlichem Erdgas.

The porcelain body is produced from the finely ground minerals kaolin, potassic feldspar and quartz, without any chemical additives. The porcelain is fired only with clean natural gas.



SCHNITTFEST

Cut-resistant

Auch bei der Dauerbeanspruchung durch scharfe Messerklingen schneidet SELTMANN Varionorm-Systemporzellan gut ab – ein Erfolg der überdurchschnittlichen Glasurhärte. Das Geschirr sieht länger besser aus und bleibt hygienisch einwandfrei.

Also when permanently exposed to sharp knife blades, SELTMANN varionorm-systemporcelain holds up well due to the extremely hard glaze. The porcelain retains its beauty and remains hygienically perfect.



DIAMANTSCHLIFF

Diamond cut

Aus produktionstechnischen Gründen sind Füße von Hartporzellanartikeln nicht glasiert. Deshalb werden sie unmittelbar nach dem Glasur- oder Glastbrand mithilfe von Diamanten geschliffen und poliert. Hierdurch wird verhindert, dass die Füße die Glasur anderer Porzellanartikel, auf die sie gestapelt werden, beschädigen oder empfindliche Oberflächen zerkratzen.

The feet of hard porcelain items are not glazed for technical reasons. This is why they are cut and polished using diamonds immediately after the glaze or glost firing. This prevents the feet from damaging the glaze of other porcelain items on which they are stacked, or from scratching other delicate surfaces.

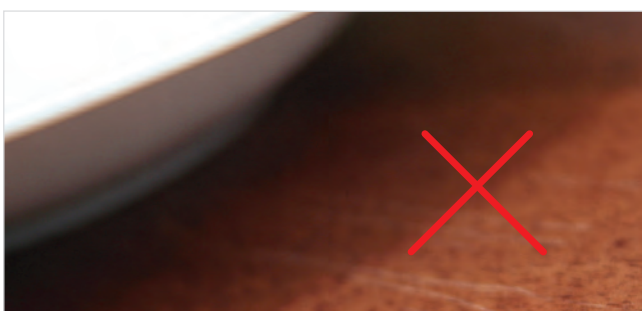

KEIN METALLABRIEB

No metal abrasion

Nur sauber geschliffene Füße können keine Metallpartikel von Metalloberflächen abreiben und auf andere Porzellanartikel, auf die sie gestapelt werden, übertragen. Hässliche Metallspuren werden so vermieden.

Only clean-cut feet cannot rub off any metal particles from metal surfaces and transfer them to other porcelain items on which they are stacked. This prevents ugly traces of metal.



ANALYSE – BERATUNG – INDIVIDUELLE LÖSUNGEN

Analysis – Consulting – Individual solutions



DIE BEDARFS- / ISTANALYSE

Requirement / Actual analysis

- Infrastruktur
 - Bedarf / Bedürfnisse
 - Abläufe
 - Personaleinsatz
 - Dienstzeiten
 - Bedarf / Bedürfnisse:
Verpflegungskonzept, Pflegepersonal,
Hol- und Lieferservice, Küchenpersonal,
Logistik, Patient / Heimbewohner
- *Infrastructure*
 - *Needs / Requirements*
 - *Processes*
 - *Deployment of personnel*
 - *Periods of service*
 - *Needs / Requirements:*
Catering concept, care workers,
pick-up and delivery service, kitchen
personnel, logistics, patients / residents



DIE KONZEPTERSTELLUNG

Concept creation

Das richtige Konzept bestimmt Effizienz und Qualität Ihrer Verpflegungsversorgung.

Grundsatz: Nicht an den Realitäten vorbei planen.

The right concept determines the efficiency and quality of your catering supply.

Principle: Don't ignore the realities when planning.



DIE SYSTEMAUSWAHL

System selection

Die richtigen Produkte bzw. Produktgruppen bestimmen die Effizienz der einzelnen Arbeitsabläufe, das reibungslose Zusammenwirken der einzelnen Bereiche im Ganzen.

The right products and/or product groups determine the efficiency of the individual workflows, and the smooth interaction of individual areas as a whole.



DAS ANGEBOTS- UND AUSSCHREIBUNGSVERFAHREN

The offer and tendering process

- Bedarfsorientierte Mengenermittlung
 - Konkrete und realistische LV-Texte
- *Demand-oriented quantity determination*
 - *Specific and realistic service level agreement texts*



UNSER SERVICE – EINFÜHRENDE MASSNAHMEN

Our service – introductory measures

- Vorbereitung der Inbetriebnahme
 - Personalschulung in allen systemrelevanten Bereichen
 - Unterstützung bei der Inbetriebnahme in allen systemrelevanten Bereichen
- *Preparing the start-up phase*
 - *Personnel training in all system-relevant areas*
 - *Support for start-up in all system-relevant areas*

FÜR JEDE ANFORDERUNG DAS RICHTIGE SYSTEM

The right system for every requirement

TABLETTSYSTEME

Tray systems

viele Möglichkeiten der Disposition ...

Many disposition options ...



UMLUFTSYSTEM

Air circulation system

Wärmen und Kühlen – in einem System

Heating and cooling – in one system



KONTAKTWÄRME

Contact heating

... die richtige Temperatur immer an der Stelle,
wo sie benötigt wird.

... the right temperature always where it's needed.



INDUKTIONSSYSTEM

Induction system

... mit erstklassiger Energieeffizienz!

... with first class energy efficiency



SONDERSYSTEME / GROSSGEBINDE / AUSSER-HAUS-SYSTEME

Special systems / Out-of-house systems

... die richtige Kombination verschiedener
System-Komponenten.

*... the right combination of different system
components*



TABLETTSYSTEME *Tray systems*

VIELE MÖGLICHKEITEN DER DISPOSITION *Many disposition options*

Passive Tablettssysteme für die Speisenverteilung im institutionellen Bereich, wie z.B. Mensen, Krankenhäuser und Altenheime, haben sich mittlerweile über Jahrzehnte bewährt und behaupten sich auch heute noch ganz hervorragend gegen die neueren, aktiven Systeme.

Insbesondere gilt dies natürlich schon aus Kostengründen, wenn die Produktions- und Verteilmethode »Cook & Serve« zur Anwendung kommt.

Passive tray systems for the distribution of meals in institutions such as canteens, hospitals and old people's homes have been tried and tested for decades and still maintain their hold against the new active systems. This is especially true for financial reasons when using the production and distribution method »cook & serve«.





Zahlreiche Unterstützungskomponenten, wie z.B. Heiz- und Kühlelemente in diversen Ausführungen, haben das Leistungsvermögen dieser Systeme sowohl im Heiß- wie auch im Kaltbereich so optimiert, dass die lebensmittelhygienischen Anforderungen hinsichtlich grenzwertiger Temperaturen unter gleichzeitiger Berücksichtigung der Zeitschiene gut erfüllt werden können.

Numerous supporting components such as heating and cooling elements in various types have optimized the efficiency of these systems both for hot and cold food, so that hygienic requirements referring to food with regard to both temperature limits and time limits can easily be complied with.



OPTIMALE SPEISENVERTEILUNG DURCH
MASSGENAUE UND SYSTEMRELEVANTE
GESCHIRRTEILE.

*Optimal meal distribution via dimensionally accurate
and system-relevant tableware units*



UNSER PORZELLAN IST MIT ALLEN FÜHRENDEN TABLETTHERSTELLERN KOMBINIERBAR

Our porcelain can be combined with all leading tray manufacturers



PASSIVE SYSTEME
passive systems

Der Tablettaufbau lässt sich zu allen Mahlzeiten mit zahlreichen Ergänzungsartikeln Ihren ganz individuellen Anforderungen und Wünschen anpassen. Das gesamte Sortiment finden Sie unter dem Bereich »Porzellan und Kunststoffdeckel«. Wir beraten Sie diesbezüglich aber auch gerne in einem persönlichen Gespräch vor Ort in Ihrer Einrichtung und präsentieren Ihnen hierbei auch die diversen Möglichkeiten.

The tray layout can be adjusted for all meals to your individual requirements and requests by means of numerous supplementary items. You find the entire assortment in the register »porcelain and plastic lids«. We would also be glad to advise you in a personal conversation in-situ at your institution where we will present various possibilities.



HEPP – PASSIVE SYSTEME

Hepp – passive systems

VARIONORM
Dekor 21101

V115 PR_Teller flach 25,5 cm
V130 PR_Schale eckig 11 x 8,5 cm
V531 PR_Suppenschale schwappsicher 0,45 ltr.

Variotherm



VARIONORM
Dekor 34690

V115 PR_Teller flach 25,5 cm
V182 PR_Platte eckig 1-tlg. 17,5 x 11 cm
V131 PR_Schale eckig 17,5 x 11 cm

Variofresh



HEPP – PASSIVE SYSTEME

Hepp – passive systems

VARIONORM Dekor 30770

V115 PR_Teller flach 25,5 cm
V130 PR_Schale eckig 11 x 8,5 cm
V531 PR_Suppschale schwappsicher 0,45 ltr.

Variomet-Wachs



VARIONORM Dekor 34689

V115 PR_Teller flach 25,5 cm
V130 PR_Schale eckig 11 x 8,5 cm
V182 PR_Platte eckig 1-tlg. 17,5 x 11 cm
V183 PR_Becher mit Henkel 0,28 ltr.

Variocool



RIEBER – PASSIVE SYSTEME

Rieber – passive systems

VARIONORM
Dekor 10428

V203 IM_Suppenschale 0,50 ltr. mit Griff
V206 IM_Salatschale rund 13 cm
V219 IM_Platte rund 3-tlg. 25,5 cm
V232 IM_Salatschale eckig 12 x 12 cm

Combitray Kunststoff-Set



VARIONORM | IMPERIAL
Dekor 20482

Varionorm

V202 IM_Suppenschale 0,45 ltr. mit Griff
V232 IM_Salatschale eckig 12 x 12 cm
V276 IM_Teller halbtief 25,5 cm

Imperial

Becher mit Hkl. 0,25 ltr.

Thermotray 2



RIEBER – PASSIVE SYSTEME

Rieber – passive systems

VARIONORM
Dekor 30770

V212 IM_Eintopfschale 1,10 ltr.
V232 IM_Salatschale eckig 12 x 12 cm
V531 PR_Suppenschale schwappsicher 0,45 ltr.

Combitray Combi-Set



VARIONORM
Dekor 34688

V115 PR_Teller flach 25,5 cm
V531 PR_Suppenschale schwappsicher 0,45 ltr.
V560 PR_Schale eckig 11 x 8 cm

Top Dining Isoliergeschirr



STIERLEN – PASSIVE SYSTEME

Stierlen – passive systems

VARIONORM
Dekor 34691

V105 PR_Suppschale 0,45 ltr.
V130 PR_Schale eckig 11 x 8,5 cm
V577 PR_Becher mit Henkel 0,25 ltr.

HotSet



VARIONORM
Dekor 21101

V130 PR_Schale eckig 11 x 8,5 cm
V131 PR_Schale eckig 17,5 x 11 cm
V145 PR_Obertasse 0,18 ltr.
V161 PR_Suppschale 0,40 ltr.
V162 PR_Teller flach 26 cm Coup

CombiSet



STIERLEN – PASSIVE SYSTEME

Stierlen – passive systems

VARIONORM Dekor 30726

- V105 PR_Suppschale 0,45 ltr.
- V120 PR_Platte rund 3-tlg. 25,5 cm Coup
- V130 PR_Schale eckig 11 x 8,5 cm
- V152 PR_Becher mit Henkel 0,25 ltr.

ThermoSet



VARIONORM weiß uni 3

- V115 PR_Teller flach 25,5 cm
- V131 PR_Schale eckig 17,5 x 11 cm
- V133 PR_Salatschale eckig 11 x 11 cm
- V183 PR_Becher mit Henkel 0,28 ltr.

CoolSet

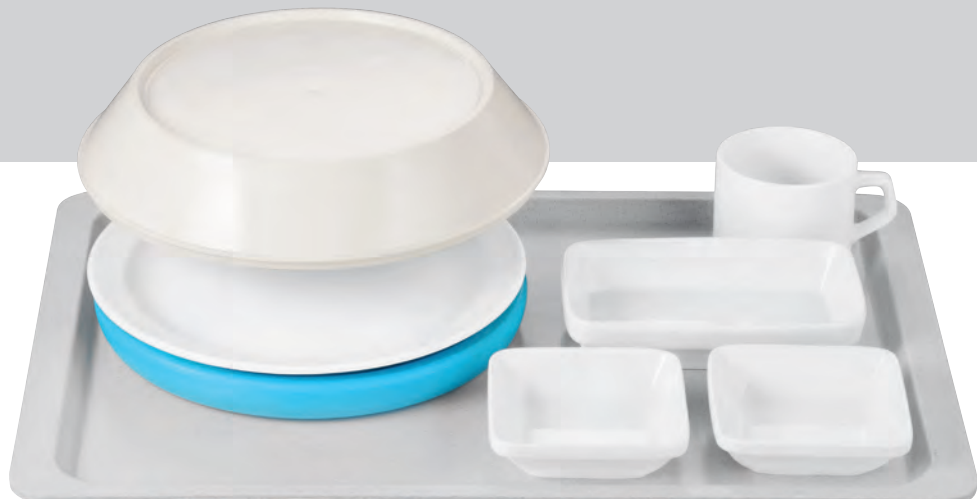

TEMP-RITE – PASSIVE SYSTEME

Temp-Rite – passive systems



VARIONORM
Dekor 20482

V130 PR_Schale eckig 11 x 8,5 cm
V131 PR_Schale eckig 17,5 x 11 cm
V138 PR_Platte rund 3-tlg. 26 cm
V152 PR_Becher mit Henkel 0,25 ltr.
V170 PR_Suppschale 0,45 ltr.

Temp-Royal

TEMP-RITE – PASSIVE SYSTEME

Temp-Rite – passive systems

VARIONORM
Dekor 11484

V114 PR_Teller halbtief 25,5 cm
V133 PR_Salatschale eckig 11 x 11 cm
V170 PR_Suppschale 0,45 ltr.

Temp-Rondo



PN – SPEISENVERTEILUNG MIT SYSTEM

PN – food distribution with system

DIE PORZELLANNORM PN SORGT FÜR HÖCHSTE EFFIZIENZ ...

The PN porcelain standard provides for maximum efficiency ...



Zeit, Raum und Ästhetik – das sind die wesentlichen Parameter, an denen sich jeder Küchenleiter bei der Beschaffung von Porzellansystemen orientiert. Es galt Geschirr-Serien zu entwickeln, deren einzelne Teile in Größe und Formgebung aufeinander abgestimmt sind und sich in die bestehenden Tablett-Systeme (z. B. GN-Format) einfügen.

Hier setzt die Porzellannorm – PN – an.

Time, space and aesthetics – these are the fundamental parameters every kitchen manager focuses on when purchasing porcelain systems.

We endeavoured to develop crockery systems whose individual components, size and shape are coordinated with each other and can be inserted into existing tray systems (e.g. GN format).

Here the PN porcelain standard applies.



TELLERSTAPLER vs. PN-STAPLER

Plate stacker vs. PN stacker

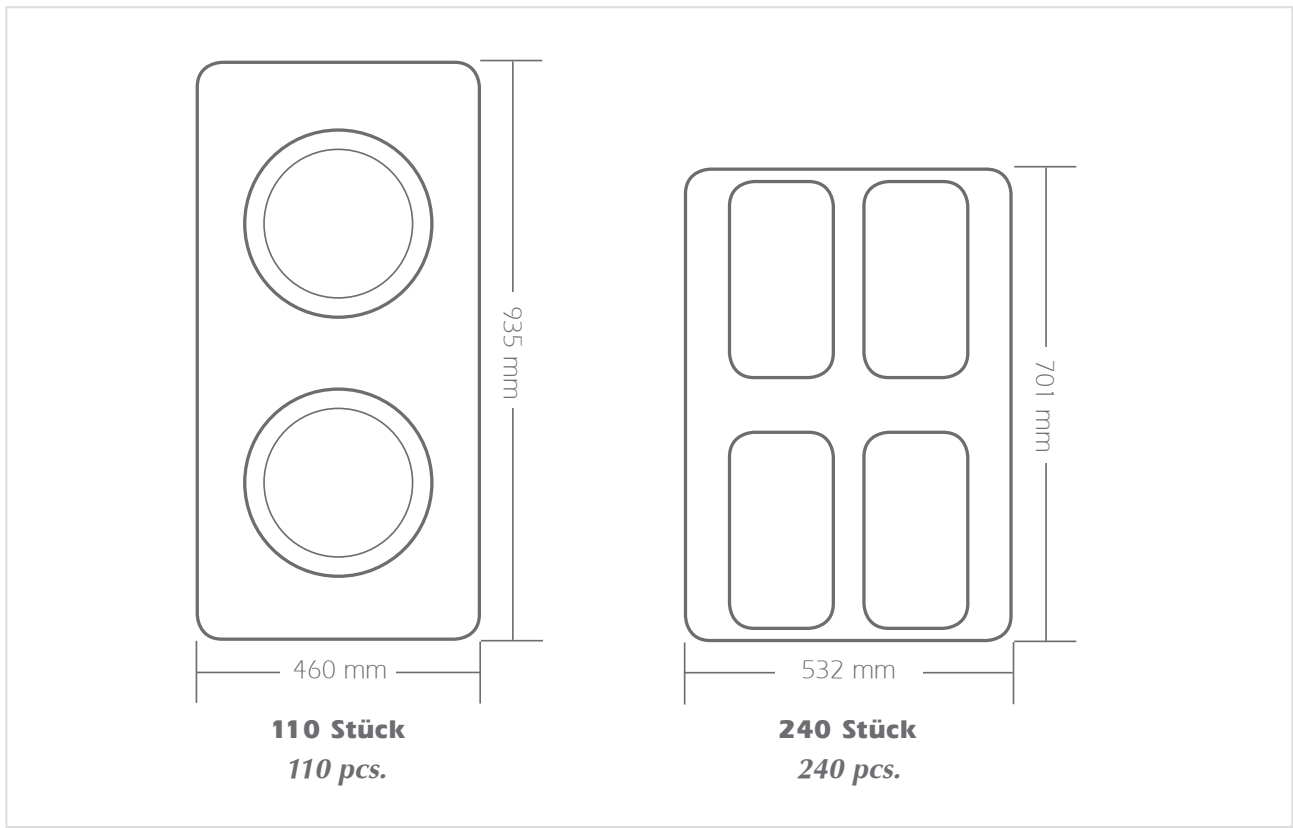



PN – AUF JEDEM TABLETT ZU HAUSE

PN – at home on any try

Die Porzellannorm PN sorgt mit ihrer System-Kompatibilität für »barrierefreie« Arbeitsprozesse.

Eine Formensprache, die allen Ansprüchen an Funktionalität und Ästhetik gerecht wird und ein erstklassiges Handling garantiert.



The PN porcelain standard provides for »barrier-free« work processes.

A use of form that fulfils all standards for functionality and aesthetics and ensures first-class handling.



UMLUFTSYSTEM *Air circulation system*

WÄRMEN UND KÜHLEN – IN EINEM SYSTEM
Heating and cooling – in one system

Tablett-Transportwagen mit Umlufttechnik eignen sich aufgrund spezieller, in die Wagen **integrierter Klimasteuerung** für die gleichzeitige Regeneration und Kühlung kompletter Mahlzeiten **auf einem Tablett**. Sie können vielfältig und in fast allen Produktions- und Verteilmethoden eingesetzt werden.

Tray transport carts with circulating air technique are suitable for simultaneous regeneration and cooling of complete meals on a single tray due to special temperature division integrated in the carts. They are very versatile and can be used for almost any production and distribution method.



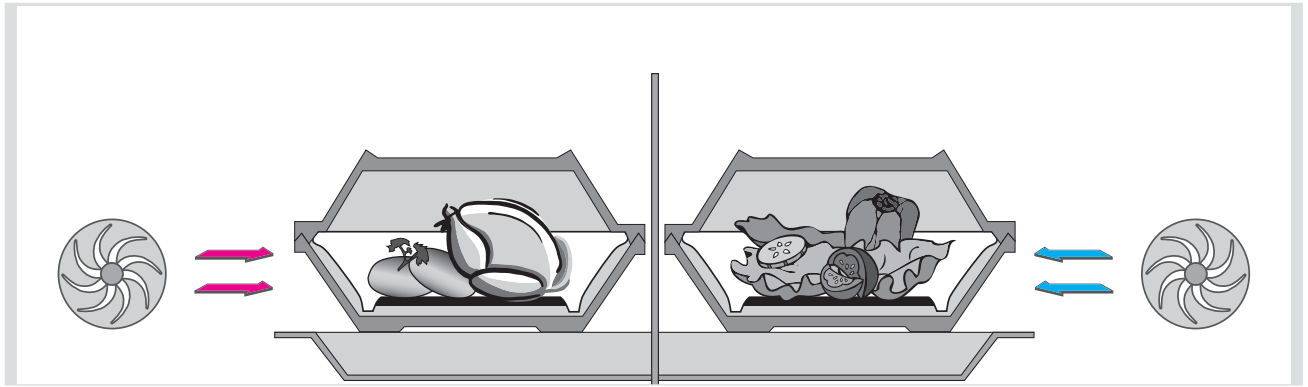

Heißluftgebläse (rot), Kaltluftgebläse (blau), portioniertes Tablett mit Klimateiler
Hot air fan (red), cold air fan (blue), tray laid out in portions with temperature divider

Alle namhaften Anbieter führen die Umlufttechnik auch in Andockversion aus, d.h. die Technischeinheit ist an zentraler Stelle fest positioniert; der Transport der fertig portionierten Tablets erfolgt mit so genannten Shuttle-Wagen, die zum **Beheizen und Kühlen** an die Andockstation angedockt werden.

All well-known providers also offer the circulating air technique as a docking option, i.e. the technical unit is stationary at a central spot, the transport of the trays laid out in portions is effected by means of so-called shuttle carts which are docked to the docking station for heating and cooling.



UMLUFTSYSTEME
 systems—circulating air

HOMOGENE REGENERATION UND KÜHLUNG KOMPLETTER MAHLZEITEN AUF EINEM TABLETT.

*Effective regeneration and cooling of complete meals
on one tray.*



BLANCO – AKTIVE SYSTEME – UMLUFT

Blanco – active systems – circulating air

Airserve Trolley / Tablett



UMLUFTSYSTEME
systems—circulating air

Varionorm Dekor 34690

V151 PR_Suppschale 0,31 ltr.
V780 PR_Teller 3-eckig 23,8 cm
V783 PR_Dessertschale 4-eckig 15 cm
Sketch Dessertschale 3-eckig 15 cm

0450 Deckel AA_DESSERT_EC_024 grau-transparent
0820 Deckel AA_DESSERT_3EC_036 grau-transparent

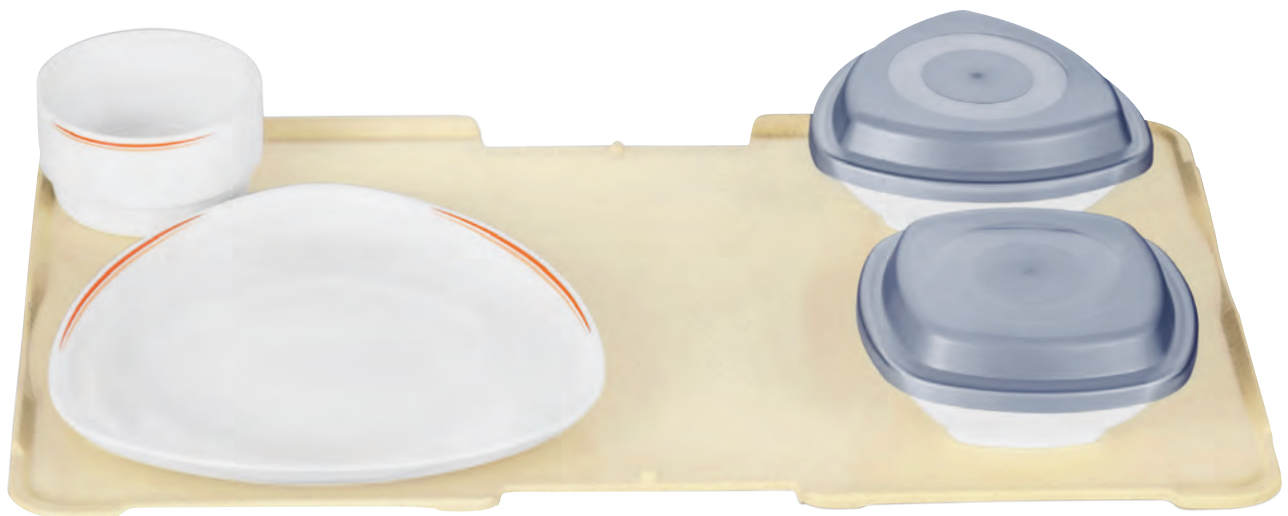

MENÜ-MOBIL – AKTIVE SYSTEME – UMLUFT

Menü-Mobil – active systems – circulating air

AirLine / Tablett



Varionorm Dekor 21101

V130 PR_Schale eckig 11 x 8,5 cm
V131 PR_Schale eckig 17,5 x 11 cm
V152 PR_Becher mit Henkel 0,25 ltr.
V782 PR_Teller rund 23 cm
V790 PR_Suppschale 0,53 ltr.

1050 Deckel KE_Schale 1185_047 glasklar
1060 Deckel KE_Schale 1117_048 glasklar



SOCAMEL – AKTIVE SYSTEME – UMLUFT

Socamel – active systems – circulating air

Ergoserv / Tablett



Varionorm Dekor 34688

- V130 PR_Schale eckig 11 x 8,5 cm
- V131 PR_Schale eckig 17,5 x 11 cm
- V145 PR_Obertasse 0,18 ltr.
- V151 PR_Suppschale 0,31 ltr.
- V177 PR_Untertasse 12,5 cm
- V781 PR_Teller 4-eckig 24 cm

- 105O Deckel KE_Schale 1185_047 glasklar
- 106O Deckel KE_Schale 1117_048 glasklar



UMLUFTSYSTEME
systems—circulating air

STIERLEN – AKTIVE SYSTEME – UMLUFT

Stierlen – active systems – circulating air

RTS Speisentransportwagen / Tablett



Varionorm Dekor 30770

V130 PR_Schale eckig 11 x 8,5 cm

V131 PR_Schale eckig 17,5 x 11 cm

V151 PR_Suppschale 0,31 ltr.

V537 PR_Becher mit Henkel 0,28 ltr.

V782 PR_Teller rund 23 cm

105O Deckel KE_Schale 1185_047 glasklar

106O Deckel KE_Schale 1117_048 glasklar



ANDOCKSTATIONEN – AKTIVE SYSTEME – UMLUFT

Docking stations – active systems – circulating air

1 MENÜ-MOBIL

2 STIERLEN

3 SOCAMEL



UMLUFTSYSTEME
systems—circulating air

KONTAKTWÄRME *Contact heating*

... DIE RICHTIGE TEMPERATUR IMMER AN DER STELLE, WO SIE BENÖTIGT WIRD
... *the right temperature always where it's needed.*

Bei der Kontaktwärmetechnik werden auf Hartporzellanteilen mit **planem Boden** portionierte Speisen über Aluminium- oder Ceranglasplatten direkt oder indirekt erwärmt. Entscheidend für die effiziente und gleichmäßige Wärmeübertragung ist dabei der großflächige, absolut plane Boden. Selbst etwas längere Transport- und/oder Standzeiten nach der Erwärmungsphase führen deshalb nur zu äußerst **geringfügigen Temperaturverlusten** oberhalb des Grenzwertes.

Contact heating technique means heating the portioned food on hard porcelain items with flat bottoms via aluminium or ceran glass plates directly or indirectly. The deciding requirement for efficient and even heat transfer is the large-surface, absolutely flat bottom. So even longer transport or standing times after the heating phase only result in very slight temperature loss above the limit.



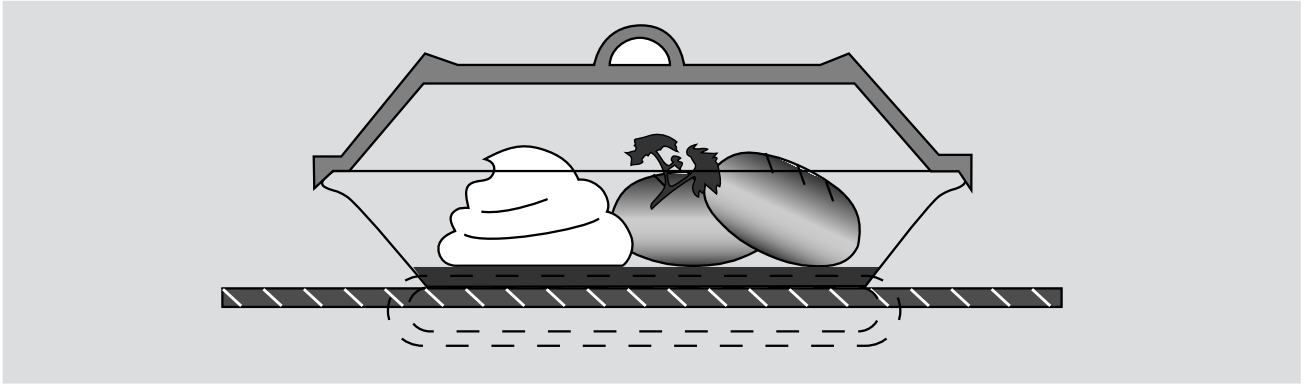

Diverse Möglichkeiten der Klimarteilung ermöglichen es z.B. in der Produktions- und Verteilmethode »Cook & Chill«, gleichzeitig heiß zu machende und kalt zu haltende Komponenten auf einem Tablett zu portionieren, während des Transportes zu kühlen und anschließend im Heißbereich zu regenerieren und im Kaltbereich weiter zu kühlen. Temperaturgrenzwerte sind so im Heiß- wie im Kaltbereich problemlos zu meistern.

Various possibilities of temperature division make it possible, e.g. in the production and distribution method »cook & chill«, to lay out portioned components to be heated and to be chilled on one tray at the same time, to cool them during transport and thereupon to regenerate them in the hot section while carrying on cooling them in the cooling section. Thus the temperature limits both in the hot and cold section can easily be managed.



KONTAKTWÄRMESYSTEME
systems—contact heating

KEINE TEMPERATURVERLUSTE DURCH
DEN ABSOLUT PLANEN BODEN.

No temperature losses via the completely flat base.



MENÜ-MOBIL – AKTIVE SYSTEME – KONTAKTWÄRME

Menü-Mobil – active systems – contact heating

ContactLine / Tablett



Varionorm weiß uni 3

V130 PR_Schale eckig 11 x 8,5 cm

105O Deckel KE_Schale 1185_047 glasklar



KONTAKTWÄRMESYSTEME
systems—contact heating

ELECTRO CALORIQUE – AKTIVE SYSTEME – KONTAKTWÄRME

Electro Calorique – active systems – contact heating

Erg'elec 4000 PLUS / Tablett



Varionorm Dekor 34281

V134 PR_Salatschale eckig 10 x 10 cm

V192 PR_Salatschale eckig 20 x 10 cm

V502 PL_Platte eckig 1-tlg. 27 x 17 cm

058O Deckel AA_SALAT_EC_12_019 grau-transparent

063O Deckel AA_SALAT_2010_032 grau-transparent



ELECTRO CALORIQUE – AKTIVE SYSTEME – KONTAKTWÄRME

Electro Calorique – active systems – contact heating

Erg'elec 4000 PLUS / Tablett



Varionorm Dekor 34691

- V130 PR_Schale eckig 11 x 8,5 cm
- V131 PR_Schale eckig 17,5 x 11 cm
- V315 PL_Teller flach 25,5 cm
- V351 PL_Suppschale 0,31 ltr.
- V537 PR_Becher mit Henkel 0,28 ltr.

- 105O Deckel KE_Schale 1185_047 glasklar
- 106O Deckel KE_Schale 1117_048 glasklar



ISECO – AKTIVE SYSTEME – KONTAKTWÄRME

Iseco – active systems – contact heating

Transtronic Evo / Tablett



Varionorm Dekor 34690

V134 PR_Salatschale eckig 10 x 10 cm

V183 PR_Becher mit Henkel 0,28 ltr.

V192 PR_Salatschale eckig 20 x 10 cm

V351 PL_Suppschale 0,31 ltr.

V646 PL_Eintopfschale schwappsicher 17,5 cm

058O Deckel AA_SALAT_EC_12_019 grau-transparent

063O Deckel AA_SALAT_2010_032 grau-transparent



ISECO – AKTIVE SYSTEME – KONTAKTWÄRME

Iseco – active systems – contact heating

Vitalis One / Tablett



Varionorm Dekor 34688

V130 PR_Schale eckig 11 x 8,5 cm

V145 PR_Obertasse 0,18 ltr.

V177 PR_Untertasse 12,5 cm

V347 PL_Teller rund 2-tlg. 23 cm

V631 PL_Suppschale schwappsicher 0,45 ltr.

1050 Deckel KE_Schale 1185_047 glasklar



ISECO – AKTIVE SYSTEME – KONTAKTWÄRME

Iseco – active systems – contact heating

Vitalis One / Tablett



Varionorm Dekor 21101

- V130 PR_Schale eckig 11 x 8,5 cm
- V131 PR_Schale eckig 17,5 x 11 cm
- V301 PL_Suppschale 0,40 ltr. mit Griff
- V366 PL_Teller tief 23 cm
- V537 PR_Becher mit Henkel 0,28 ltr.

- 105O Deckel KE_Schale 1185_047 glasklar
- 106O Deckel KE_Schale 1117_048 glasklar



TEMP-RITE – AKTIVE SYSTEME – KONTAKTWÄRME

Temp-Rite – active systems – contact heating

Temp-Futura / Tablett



Varionorm Dekor 34691

V130 PR_Schale eckig 11 x 8,5 cm

V181 PR_Halbmondschale

V365 PL_Eintopfeller 23 cm

V537 PR_Becher mit Henkel 0,28 ltr.

V611 PL_Suppenschale 0,40 ltr.

102O Deckel KE_HALBMOND_046 glasklar

105O Deckel KE_Schale 1185_047 glasklar



KONTAKTWÄRMESYSTEME
systems—contact heating

INDUKTIONSSYSTEM *Induction system*

... MIT ERSTKLASSIGER ENERGIE-EFFIZIENZ
... with first class energy efficiency

Den technisch innovativsten und **sehr effektiven** Weg, Speisen zu regenerieren und warm zu halten, bietet die Induktionstechnik. Dazu ist das Induktionsporzellan »Indumatic« von SELTMANN WEIDEN am Boden mit einer auf die diversen Systeme abgestimmten Spezialbeschichtung ausgestattet.

Über diese Beschichtung, in Verbindung mit den in Spulenträgern eingelassenen Induktionsspulen, die sich im Tablett-Transportwagen oder an der Andockstation befinden, werden die portionierten Speisen gleichmäßig und schonend erwärmt.

Induction technique offers the technically most innovative and very efficient way to regenerate food and to keep it hot. For this purpose the bottoms of the induction porcelain »Indumatic« by SELTMANN WEIDEN are equipped with a special coating adapted to the various systems.

The portioned food is heated evenly and gently via this coating in combination with the induction coils inserted in coil holders, which are located in the tray transport cart or at the docking station.



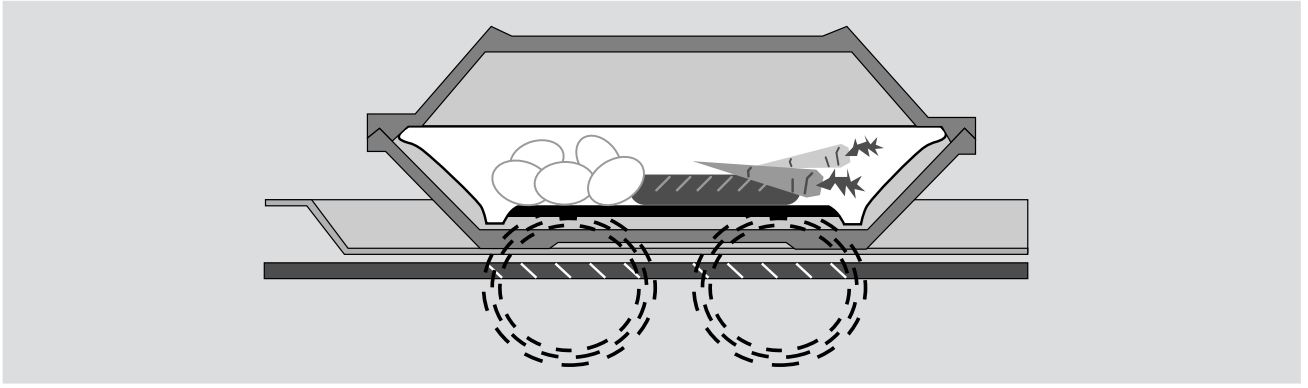

Das über die Programmierung aktivierte System erkennt automatisch die induktiv beschichteten Geschirrtteile und erwärmt nur diese im Rahmen der voreingestellten Leistung und Zeit. Nicht beschichtete Geschirrtteile bleiben kalt, auch wenn sie auf dem Tablett im Bereich der Induktionsspulen stehen. Das spart natürlich in besonderem Maße Energie.

The system activated via the programming automatically recognizes the inductively coated porcelain items and heats only these within the preset output and time. Non-coated porcelain items remain cold, even if they are sitting in the induction coil section on the tray. Obviously this saves a considerable amount of energy.



FLEXIBLE GESTALTUNGSMÖGLICHKEIT UND PLATZNUTZUNG DER KALTKOMPONENTEN AUF DEM EINZELTABLETT

*Flexible design options and space utilisation on the
individual tray*



BLANCO – AKTIVE SYSTEME – INDUKTION

Blanco – active systems – induction

Recaldo Classico / Tablett



Varionorm Dekor 20482



HUPFER – AKTIVE SYSTEME – INDUKTION

Hupfer – active systems – induction

ITW 2/20 / Tablett



Varionorm weiß

V545 PR_Teller rund 24 cm

V549 PR_Suppenschale 0,45 ltr.

V556 PR_Platte eckig 1-tlg. 16 x 11 cm

V562 PR_Schale eckig 11 x 8 cm hoch



HUPFER – PN

Hupfer – PN

Tabletts

Varionorm weiß

V551 PR_Schale eckig 11 x 8 cm
V553 PR_Schale eckig 16 x 11 cm
V557 PR_Schale eckig 22 x 16 cm

135O Deckel FV_Schale1108_062 glasklar-milchig
136O Deckel FV_Schale1611_063 glasklar-milchig
137O Deckel FV_Teller2216_064 glasklar-milchig



Varionorm weiß

V152 PR_Becher mit Henkel 0,25 ltr.
V552 PR_Setplatte 16 x 11 cm
V553 PR_Schale eckig 16 x 11 cm
V554 PR_Platte eckig 1-tlg. 22 x 16 cm
V562 PR_Schale eckig 11 x 8 cm hoch

152O Deckel FV_Schale1108_071 glasklar-milchig



Varionorm weiß

V555 PR_Teller eckig 1-tlg. 22 x 16 cm
V556 PR_Platte eckig 1-tlg. 16 x 11 cm
V562 PR_Schale eckig 11 x 8 cm hoch

137O Deckel FV_Teller2216_064 glasklar-milchig
152O Deckel FV_Schale1108_071 glasklar-milchig
153O Deckel FV_Pla1611_ho_070 glasklar-milchig



MENÜ-MOBIL – AKTIVE SYSTEME – INDUKTION

Menü-Mobil – active systems – induction

InductLine / Tablett



Varionorm Dekor 21101

V562 PR_Schale eckig 11 x 8 cm hoch

V564 PR_Schale eckig 11 x 11 cm hoch



SCHMALZ – AKTIVE SYSTEME – INDUKTION

Schmalz – active systems – induction

ITW 2000 Clima-Control



Varionorm Dekor 54653



TEMP-RITE – AKTIVE SYSTEME – INDUKTION

Temp-Rite – active systems – induction

Temp-Induc / Tablett



Varionorm Dekor 30770

V170 PR_Suppschale 0,45 ltr.

V215 IM_Teller flach 25,5 cm

V232 IM_Salatschale eckig 12 x 12 cm



ANDOCKSTATIONEN – AKTIVE SYSTEME – INDUKTION

Docking stations – active systems – induction



- 1 TEMP-RITE
- 2 BLANCO
- 3 MENÜ-MOBIL
- 4 HUPFER

SONDERSYSTEME *special systems*

... DIE RICHTIGE KOMBINATION VERSCHIEDENER SYSTEM-KOMPONENTEN
... the right combination of different system components

Unter Sondersystemen sind derzeit jene Systeme zu verstehen, die ihre Leistungsfähigkeit aus dem kombinierten Einsatz verschiedener technischer Möglichkeiten beziehen. Die bislang bekannteste Variante ist der Einsatz von Induktion in Verbindung mit einem Clochensystem. Anders als bei der üblichen Nutzung der Induktionstechnik wird hierbei allerdings nicht ein Porzellangeschirrtteil induktiv erwärmt, sondern die entsprechend induktiv gestaltete und gleichzeitig isolierende Unter cloche des Systems.

Special systems currently mean such systems which obtain their efficiency by using a combination of different technical procedures. The best-known type so far is the use of induction in combination with a cloche system. However, in contrast to the common use of induction technique, it is not a porcelain item which is heated inductively but the inductively designed and simultaneously insulating bottom cloche of the system.





Das entsprechende Geschirrtel wird zusätzlich in einem Geschirrspender erwärmt. So läßt sich eine deutlich verbesserte Warmhaltezeit in der Produktions- und Verteilmethode »Cook & Serve« erzielen. SELTMANN WEIDEN hält auch für diese technischen Möglichkeiten alle systemrelevanten Geschirrtel vor.

Additionally the corresponding porcelain item is heated in a porcelainware distributor. Thus the warming time in the production and distribution method »cook & serve« is considerably improved. SELTMANN WEIDEN offers all system-relevant porcelain items also for these technical procedures.

SCHMALZ INDUKTIONS BAND



ISECO – AKTIVE SYSTEME – SONDERSYSTEME

Iseco – active systems – special systems

Energis réversible



TEMP-RITE – AKTIVE SYSTEME – SONDERSYSTEME

Temp-Rite – active systems – special systems

Mealbutler



GROSSGEBINDE – AKTIVE SYSTEME

Food in bulk – active systems

REGENERIER-SYSTEME FÜR GROSSGEBINDE

Aus der dezentralen Speisenverteilung, vornehmlich in Einrichtungen der Seniorenpflege, sind sie fast allen bekannt: 2- oder 3-Becken Schöpf- oder Speisenausgabewagen, wahlweise mit beheizbaren und/oder statisch kühlbaren, geschlossenen Unterbauten für die Essenausgabe in Stations- oder Wohnbereichen. Leistungsmäßig begrenzt, eignen sie sich ausschließlich für die Produktions- und Verteilmethode »Cook & Serve«.

Der aus dem allgemeinen Kostendruck resultierende Rationalisierungszwang und permanent steigende Anforderungen an die Qualität der Verpflegungsversorgung, insbesondere auch in lebensmittelhygienischer Hinsicht, haben auch in diesem Gerätesegment zu durchgreifenden Innovationen geführt.

Zwischenzeitlich verfügen fast alle Systemanbieter auch über entsprechende Technik für die Regenerierung im Großgebäude (Gastronorm mit Unterteilungen) zum kombinierten Einsatz mit allen heute gängigen Produktions- und Verteilmethoden.

SELTMANN WEIDEN steuert zu diesen Regenerierverfahren qualitativ hochwertige Gastronormbehälter in diversen Größen mit planem Boden bei. Diese Behälter ermöglichen zum einen die einwandfreie Regenerierung der Speisen auf die geforderten Mindesttemperaturen. Zum anderen ermöglichen sie aber auch die optisch anspruchsvolle Präsentation der regenerierten Speisen sowohl bei der dezentralen Verteilung im Wohn- oder Stationsbereich, als auch auf dem gedeckten Tisch.

Außerdem verfügt SELTMANN WEIDEN mit der Geschirrserie »VITALIS«, die u.a. speziell auf die Anforderungen im Altenheimbereich abgestimmt ist, und anderen ausgewählten Systemartikeln über ein umfangreiches Ergänzungsprogramm, mit dem jeder Systemanwender allen sich stellenden Anforderungen bestens gerecht werden kann.

REGENERATION SYSTEMS FOR FOOD IN BULK

Most people know them from decentralized distribution of meals, especially in institutions which care for senior citizens: Scoop or food distributor carts with 2 or 3 basins, optionally with heatable and/or statically coolable, closed substructures for distributing meals in wards or rooms in old people's homes. Due to limited capacity such carts are only suitable for the production and distribution method »cook & serve«.

The need for rationalization because of generally rising costs and the continually increasing requirements concerning the quality of catering, especially with regard to food hygiene, have resulted in radical innovations for such equipment.

Meanwhile most system providers offer the corresponding technique for regeneration of food in bulk (Gastronorm with compartments) for combined use with all current production and distribution methods.

The contribution of SELTMANN WEIDEN to these regeneration procedures comprises high-quality Gastronorm containers in various sizes with flat bottoms. These containers facilitate perfect regeneration of meals to the required minimum temperatures as well as the optically appealing presentation of the regenerated meals both for decentralized distribution in the rooms or wards of old people's homes and on the laid table.

Moreover SELTMANN WEIDEN offers a large supplementary program comprising the porcelain series »VITALIS« which was specially designed to fulfil the conditions in old people's homes as well as other select system items, so each system user will be able to comply with any requirement they may be confronted with.

GROSSGEBINDE – AKTIVE SYSTEME – FRÜHSTÜCKSWAGEN

Food in bulk – active systems – breakfast trolleys

GROSSGEBINDE
regeneration of food in bulk

FRÜHSTÜCKSWAGEN



- 1 TEMP-RITE
- 2 ISECO
- 3 RIEBER



GROSSGEBINDE – AKTIVE SYSTEME – REGENERIERWAGEN

Food in bulk – active systems – regeneration trolleys

REGENERIERWAGEN



GROSSGEBINDE – AKTIVE SYSTEME – REGENERIERWAGEN

Food in bulk – active systems – regeneration trolleys

GROSSGEBINDE
regeneration of food in bulk

REGENERIERWAGEN

- 1 TEMP-RITE
- 2 STIERLEN
- 3 RIEBER
- 4 SOCAMEL
- 5 ISECO
- 6 BLANCO



GROSSGEBINDE – TRANSPORTBOXEN

Food in bulk – transport boxes

TRANSPORTBOXEN



- 1 BLANCO
- 2 RIEBER
- 3 THERMOHAUSER

GROSSGEBINDE – TRANSPORTBOXEN

Food in bulk – transport boxes

GROSSGEBINDE
regeneration of food in bulk

TRANSPORTBOXEN



AUSSER HAUS-SYSTEME – EINZELPORTIONEN

Out of house systems – individual portions

AUSSER-HAUS – SYSTEME

Out-of-house systems

Außer-Haus-Systeme sind besser bekannt unter dem landläufigen Begriff »Essen auf Rädern«, einem Wachstumsmarkt im Bereich der Gemeinschaftspflege, speziell für alle Senioren und körperlich Beeinträchtigte, die sich ihre Mobilität weitgehend erhalten haben und »die eigenen vier Wände« der Heimunterbringung vorziehen. Das »Essen auf Rädern« ist dann oft eine, aus den unterschiedlichsten Gründen, sehr willkommene Erleichterung bei der Bewältigung des Tagesablaufes.

Out-of-house systems are better known as »meals on wheels«, a growing market in the catering field, especially for all senior citizens and physically challenged people who have maintained their mobility to a great extent and rather live within their own four walls than in an old people's home. For these people »meals on wheels« are, for different reasons, a welcome relief which makes everyday life easier.

RIEBER





Das SELTMANN-WEIDEN-Programm beinhaltet auch für diesen Verpflegungsbereich exklusive Geschirrserien für diverse Systemanbieter.

Also for this catering field the program by Seltmann Weiden comprises exclusive porcelain series for various system providers.

THERMOHAUSER



DEKORE UND VIGNETTEN / LOGOS

Decoration and vignettes / logos

... IHRE GANZ INDIVIDUELLE »NOTE« ...

... Your own individual »style« ...

Sie suchen ein System-Porzellan, das sich werbewirksam in das Erscheinungsbild Ihres Unternehmens einfügt?

Auch das ist möglich. Unabhängig von der breiten Dekorauswahl läßt sich SELTMANN System-Porzellan im Rahmen Ihrer Corporate Identity optimal imagefördernd und geschmackvoll gestalten. Mit Ihrem Logo, Ihrer Firmen-Vignette und selbstverständlich in Ihrer Hausfarbe.

Are you looking for porcelain system matching the image of your company?

This is possible as well.

Apart from the wide choice of decorations SELTMANN system porcelain may be designed tastefully to match your corporate identity, thus promoting and enhancing your corporate image, your company logo and colours, of course.



ZEICHEN VOLLENDETER TISCHKULTUR

A symbol of finest tableware culture

... IHRE INDIVIDUELLE »DEKORATION« ...
... *Your individual »crest« ...*

Ihre Küche bringt Gourmets ins Schwärmen.
Interieur, Dekoration, Accessoires, Gläser
... alles ist vom Feinsten.
Fehlt nur noch ein kleines, doch entscheidendes Detail: die stilvolle Vignette Ihres Hauses auf edlem Porzellan.

Your cooking makes gourmets go into raptures. The interior, decoration, accessoires, glasses ... everything is of finest quality. There is only a small, but essential detail missing: the stylish crest of your house on elegant porcelain.



ANALYSE – BERATUNG – INDIVIDUELLE LÖSUNGEN

Analysis – Consulting – Individual solutions



① DESIGN-ERSTELLUNG

Creating the design

Für Sie entwickeln unsere Designer – nach Ihren Wünschen oder auch ganz frei – einen individuellen Dekor.
Wenn Sie bereits Ihr eigenes Logo haben, übertragen wir dieses gerne nach Ihren Platzierungswünschen.

Our designers will create a custom-made motif, either from scratch or to your own specification. If you already have your own logo, we can turn it into a motif positioned exactly the way you want it.



② DESIGN-SIMULATION

Simulating the motif

Damit Sie schon von Beginn an wissen wie Ihr neuer Dekor aussieht, erstellen wir Ihnen eine Computer-Simulation.

To show you exactly what your new motif will look like right from the start, we will create a simulated version.

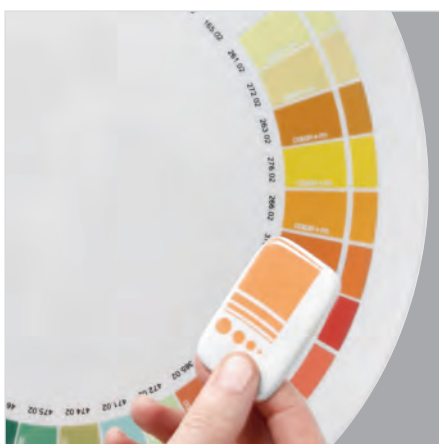

③ MUSTER-PRODUKTION

Making a sample

Noch vor Fertigung der Liefermenge erhalten Sie Muster-Exemplare über die von Ihnen bestellten Artikel, so dass Sie die Originalität Ihres Logos oder Ihres Dekors in Form und Farbe bestätigen und freigeben können.

Before production gets underway, we will send you samples of your order so you can check and approve the rendering of your logo or motif.

SO REALISIEREN WIR IHRE WÜNSCHE

How we realise your wishes

④ FERTIGUNG

Production

Für die Produktion der Bestellmenge werden Druckbilder als Abzieh-/Schiebebilder entwickelt und perfekt platziert. Durch den späteren Brand erhalten die grafischen Elemente ihre endgültige Anmutung und farbenprächtige Brillanz.

To manufacture your order, the motif is reproduced on decals or transfers which are then carefully positioned on the article. When the items are fired, the graphic motifs acquire their final brilliance and full effect.



⑤ QUALITÄTS-KONTROLLE

Quality-control

Unserer Qualitäts-Kontrolle entgeht nichts. Selbst kleinste Unregelmäßigkeiten werden spätestens mithilfe von Lichtspiegelungen sichtbar und der fehlerhafte Artikel aussortiert.

Our quality control process is very stringent. With the help of a reflection test, even the tiniest irregularities are detected and any imperfect items are removed from the process.



The famous icing on the cake

DAS BERÜHMTE TÜPFELCHEN AUF DEM »i«

Hochwertiges Porzellan ist nicht nur ein optischer Glanzpunkt, sondern auch ein Imagefaktor ersten Ranges. Besonders, wenn jedes Geschirrtel das »persönliche« Logo Ihres Hauses trägt. Schon auf den ersten Blick spürt der verwöhnte Gast den hohen Anspruch, die Exklusivität, die hier auf elegante Weise Zeichen setzt.

Top quality porcelain is not only an optical highlight but also a first-rate image factor. Especially if each porcelain item bears the »personalized« crest of your house. At first glance your discriminating guests will feel the high standard, the exclusivity which shows in a most elegant way.



PORZELLAN & KUNSTSTOFFDECKEL

ARTIKEL NACH V-NUMMER

		Seite			Seite			Seite
VARIONORM			V139	PR_Suppenschale 0,31 ltr. m. Griff	76	V183	PR_Becher mit Henkel 0,28 ltr.	95
V101	PR_Suppenschale 0,40 ltr. m. Griff	76	V140	PR_Portionskanne 0,35 ltr.	94	V186	PR_Teller rund 3-tlg. 23 cm	86
V103	PR_Suppenschale 0,50 ltr. m. Griff		V142	PR_Becher mit Henkel 0,32 ltr.		V187	PR_Suppenschale 0,30 ltr. mit Hkl.	77
V104	PR_Suppenschale 0,90 ltr. m. Griff		V143	PR_Obertasse 0,18 ltr.		V189	PR_Schale eckig 3-tlg. 20x10 cm	90
V105	PR_Suppenschale 0,45 ltr.		V144	PR_Untertasse 13,5 cm		V190	PR_Salatschale rund 12 cm	
V106	MA_Salatschale rund 13 cm		88	V145		PR_Obertasse 0,18 ltr.	V191	PR_Schale eckig 9x9 cm
V107	MA_Salatschale rund 15 cm	V146		PR_Untertasse 15 cm		V192	PR_Salatschale eckig 20x10 cm	
V108	PR_Salatschale rund 12 cm	89	V147	PR_Teller rund 2-tlg. 23 cm	86	V199	PR_Eierbecher gross	96
V109	PR_Salatschale rund 15 cm		V150	PR_Teller flach 23 cm	82	V201	IM_Suppenschale 0,40 ltr. m. Griff	77
V110	PR_Eintopfschale 0,95 ltr.	80	V151	PR_Suppenschale 0,31 ltr.	77	V202	IM_Suppenschale 0,45 ltr. m. Griff	78
V111	PR_Eintopfschale 1,00 ltr.		V152	PR_Becher mit Henkel 0,25 ltr.	94	V203	IM_Suppenschale 0,50 ltr. m. Griff	
V112	PR_Eintopfschale 1,10 ltr.		V153	PR_Becher mit Henkel 0,30 ltr.	95	V204	IM_Suppenschale 0,90 ltr. m. Griff	
V113	PR_Eintopfschale 1,20 ltr.		V161	PR_Suppenschale 0,40 ltr.	77	V205	IM_Suppenschale 0,45 ltr.	
V114	PR_Teller halbtief 25,5 cm	82	V162	PR_Teller flach 26 cm Coup	82	V206	IM_Salatschale rund 13 cm	91
V115	PR_Teller flach 25,5 cm		V164	PR_Teller halbtief 26 cm Coup				
V119	PR_Platte rund 3-tlg. 25,5 cm	85	V165	PR_Eintopfeller 23 cm	80	V210	IM_Eintopfschale 0,90 ltr	81
V120	PR_Platte rund 3-tlg. 25,5 cm Coup		V170	PR_Suppenschale 0,45 ltr.	77	V212	IM_Eintopfschale 1,10 ltr.	
V125	PR_Platte eckig 1-tlg. 20x20 cm		V171	PR_Salatschale eckig 20x10 cm	90	V215	IM_Teller flach 25,5 cm	83
V126	PR_Platte eckig 1-tlg. 18x18 cm		V172	PR_Schale eckig 10x10 cm				
V128	PR_Platte eckig 1-tlg. 16x11 cm		V174	PR_Teller flach 22,5 cm	83	V177	PR_Untertasse 12,5 cm	95
V129	PR_Schale eckig 13x9 cm	89	V178	PR_Eierbecher ohne Ablage	96	V181	PR_Halbmondschale	
V130	PR_Schale eckig 11x8,5 cm		V182	PR_Platte eckig 1-tlg. 17,5x11 cm		86		
V131	PR_Schale eckig 17,5x11 cm		V134	PR_Salatschale eckig 10x10 cm	90			
V133	PR_Salatschale eckig 11x11 cm	V135	PR_Salatschale eckig 12x12 cm					
V136	PR_Setplatte 1 Spiegel	96						
V137	PR_Setplatte 2 Spiegel							
V138	PR_Platte rund 3-tlg. 26 cm	85						



ARTIKELÜBERSICHT

ARTIKEL NACH V-NUMMER

		Seite			Seite			Seite
V219	IM_Platte rund 3-tlg. 25,5 cm	86	V533	PR_Schale eckig 14x8,5 cm	92	V557	PR_Schale eckig 22x16 cm	93
V232	IM_Salatschale eckig 12x12 cm	91	V537	PR_Becher mit Henkel 0,28 ltr.	95	V560	PR_Schale eckig 11x8 cm	
V240	IM_Portionskanne 0,35 ltr.	95	V540	PR_Untertasse 15 cm		V561	PR_Setplatte großer Spiegel	96
V251	IM_Suppenschale 0,31 ltr	78	V545	PR_Teller rund 24 cm	83	V562	PR_Schale eckig 11x8 cm hoch	93
V260	IM_Platte rund 3-tlg. 3/3 25,5 cm	86	V547	PR_Eintopfschale niedrig 20 cm	81	V563	PR_Platte eckig 1-tlg. 22x11 cm	87
V276	IM_Teller halbtief 25,5 cm	83	V548	PR_Suppenschale schwappsicher 0,45 ltr.	79	V564	PR_Schale eckig 11x11 cm hoch	93
V293	IM_Salatschale rund 10 cm	91	V549	PR_Suppenschale 0,45 ltr.		V577	PR_Becher mit Henkel 0,25 ltr.	96
V295	IM_Platte rund 2-tlg. 25,5 cm	87	V551	PR_Schale eckig 11x8 cm	92	V591	PR_Eintopf 1,00 ltr.	81
V501	PR_Suppenschale 0,30 ltr. m. Griff	79	V552	PR_Setplatte 16x11 cm	96	V645	PR_Schale eckig 17x10 cm	93
V504	PR_Platte eckig 1-tlg. 14x8 cm	87	V553	PR_Schale eckig 16x11 cm	92	V730	PR_Teller flach 23 cm	84
V505	PR_Schale eckig 14x8 cm	92	V554	PR_Platte eckig 1-tlg. 22x16 cm	87	V731	PR_Teller rund 2-tlg. 23 cm	88
V506	PR_Schale eckig 17x12 cm		V555	PR_Teller eckig 1-tlg. 22x16 cm	83	V770	PR_Teller flach 20,5 cm	84
V507	PR_Schale eckig 8x8 cm		V556	PR_Platte eckig 1-tlg. 16x11 cm	87	V780	PR_Teller 3-eckig 23,8 cm	84
V508	PR_Platte eckig 1-tlg. 17x17 cm	87			V781	PR_Teller 4-eckig 24 cm		
V509	PR_Teller flach 19,7 cm	83			V782	PR_Teller rund 23 cm		
V511	PR_Portionskanne 0,27 ltr.	95			V783	PR_Dessertschale 4-eckig 15 cm	93	
V514	PR_Salatschale eckig 12x12 cm	92			V787	PR_Portionskanne 0,31 ltr.	96	
V515	PR_Suppenschale 0,40 ltr. m. Griff	79			V788	PR_Teller 4-eckig 2-tlg. 24 cm	88	
V516	PR_Salatschale eckig 12,5x12,5 cm	92			V789	PR_Teller 4-eckig 2-tlg. 24 cm		
V531	PR_Suppenschale schwappsicher 0,45 ltr.	79			V790	PR_Suppenschale 0,53 ltr.	79	



PORZELLAN & KUNSTSTOFFDECKEL

ARTIKEL NACH V-NUMMER

		Seite			Seite			Seite
PLANO			V354	PL_GN-Schale 1/6	106	V611	PL_Suppschale 0,40 ltr.	98
V301	PL_Suppschale 0,40 ltr. mit Griff	97	V356	PL_Platte rund 2-tlg. 25,5 cm Coup	103	V620	PL_Suppschale	105
V308	PL_Salatschale rund 12 cm	105	V357	PL_Schale eckig 1-tlg. 24,5x19 cm		V621	PL_Schale hoch 11x8,5 cm	
V312	PL_Eintopfschale 1,10 ltr.	99	V358	PL_Schale eckig 2-tlg. 24,5x19 cm	V622	PL_Schale hoch 17,5x11 cm	98	
V315	PL_Teller flach 25,5 cm	100	V365	PL_Eintopfteller 23 cm	99	V631	PL_Suppschale schwappsicher 0,45 ltr.	98
V316	PL_Teller halbtief 25,5 cm	101	V366	PL_Teller tief 23 cm	101	V633	PL_Teller 4-eckig 24 cm	102
V317	PL_Teller flach 24,5 cm Coup		V367	PL_Suppschale 0,26 ltr. mit Hkl.	97	V634	PL_Teller 4-eckig 2-tlg. 24 cm	104
V319	PL_Platte rund 3-tlg. 25,5 cm	102	V368	PL_Sauciere 0,10 ltr.	106	V635	PL_Eintopfschale schwappsicher 21 cm	100
V320	PL_Platte rund 3-tlg. 25,5 cm Coup		V369	PL_Teller tief 19,5 cm Coup	101	V637	PL_GN-Schale 1/2 55 mm	106
V321	PL_Platte rund 3-tlg. 24,5 cm Coup		V375	PL_GN-Schale niedrig 1/9	106	V646	PL_Eintopfschale schwappsicher 17,5 cm	100
V325	PL_Platte eckig 1-tlg. 20x20 cm	103	V380	PL_Sauciere 0,09 ltr. mit Henkel	106	V647	PL_Teller rund 23 cm	102
V330	PL_Schale eckig 11x8,5 cm	105	V386	PL_Teller rund 3-tlg. 23 cm	103	V648	PL_Suppschale 0,31 ltr.	98
V334	PL_Salatschale eckig 10x10 cm		V387	PL_Suppschale 0,30 ltr. mit Hkl.	97	V765	PL_Eintopfteller 23 cm	100
V339	PL_Suppschale 0,31 ltr.	97	V389	PL_Teller rund 2-tlg. 23 cm	104			
V347	PL_Teller rund 2-tlg. 23 cm	103	V392	PL_Salatschale eckig 20x10 cm	105			
V348	PL_GN-Schale 1157 1/3	106	V397	PL_Suppschale 0,30 ltr. m. 2 Hkl.	97			
V350	PL_Teller flach 23 cm	101	V502	PL_Platte eckig 1-tlg. 27x17 cm	104			
V351	PL_Suppschale 0,31 ltr.	97	V503	PL_Platte eckig 2-tlg. 27x17 cm	104			
			V603	PL_Suppschale 0,30 ltr. o. Hkl.	98			
			V608	PL_Platte rund 13 cm	104			
			V609	PL_Eintopfschale 0,50 ltr.	99			
			V610	PL_Eintopfschale 0,40 ltr.				



ARTIKELÜBERSICHT

ARTIKEL NACH V-NUMMER

		Seite
ELFENBEIN		
V215 V232 V312 V325 V334	IM_Teller flach 25,5 cm IM_Salatschale eckig 12x12 cm PL_Eintopfschale 1,10 ltr. PL_Platte eckig 1-tlg. 20x20 cm PL_Salatschale eckig 10x10 cm	107
V348 V350 V354 V367 V368 V375	PL_GN-Schale 1157 1/3 PL_Teller flach 23 cm PL_GN-Schale 1/6 PL_Suppschale 0,26 ltr. mit Hkl. PL_Sauciere 0,10 ltr. PL_GN-Schale niedrig 1/9	108
V380 V387 V389 V392 V397 V535	PL_Sauciere 0,09 ltr. mit Hkl. PL_Suppschale 0,30 ltr. mit Hkl. PL_Teller rund 2-tlg. 23 cm PL_Salatschale eckig 20x10 cm PL_Suppschale 0,30 ltr. m. 2 Hkl. PR_Dressingschälchen 0,08 ltr.	109



PORZELLAN & KUNSTSTOFFDECKEL

ARTIKELNUMMER	VE	Inhalt in ltr.	Gewicht in gr.	Höhe in mm	Stapelhöhe 11 St. in mm	Ø in mm	Material	Temp. bis
---------------	----	----------------	----------------	------------	-------------------------	---------	----------	-----------

SUPPENSCHALEN

	V101 PR_Suppenschale 0,40 ltr. mit Griff	6	0,35	275	61	244	122		
	passende Kunststoffdeckel:								
	021O Deckel FN_SUSCHA_040_006 dunkelbraun	1		45	13	146	126	PP	83°C
	028O Deckel FK_SUSCHA_040_006 grau	1		41	13	146	126	PP	83°C
	036O Deckel FL_SUSCHA_040_006 flieder	1		42	13	146	126	PP	83°C
079O Deckel GR_SUSCHA_040_006 warm grey	1		62	13	144	126	PBT	170°C	



	V103 PR_Suppenschale 0,50 ltr. mit Griff	6	0,50	335	69	272	132		
	passende Kunststoffdeckel:								
	007O Deckel AA_SUSCHA_050_007 grau-transparent	1		53	13	134	140	PSU	170°C
	022O Deckel FN_SUSCHA_050_008 dunkelbraun	1		60	14	152	137	PP	83°C
	029O Deckel FK_SUSCHA_050_008 grau	1		58	14	152	139	PP	83°C
	037O Deckel FL_SUSCHA_050_008 flieder	1		58	14	152	139	PP	83°C
	080O Deckel GR_SUSCHA_050_008 warm grey	1		81	14	153	139	PBT	170°C
	113O Deckel FV_SUSCHA_050_007 glasklar-milchig	1		32	13	128	139	PP	88°C
	156O Deckel FY_SUSCHA_050_007 grau-transparent	1		45	13	134	140	PP	80°C



	V104 PR_Suppenschale 0,90 ltr. mit Griff	4	1,00	505	71	304	172		
	passende Kunststoffdeckel:								
	023O Deckel FN_SUSCHA_090_010 dunkelbraun	1		77	12	121	180	PP	83°C
	030O Deckel FK_SUSCHA_090_010 grau	1		79	12	121	180	PP	83°C
	038O Deckel FL_SUSCHA_090_010 flieder	1		79	12	121	180	PP	83°C
148O Deckel GR_Eintopf1,0_010 warm grey	1		110	12	122	178	PBT	170°C	



	V105 PR_Suppenschale 0,45 ltr.	4	0,45	285	54	201	139		
	passende Kunststoffdeckel:								
	046O Deckel AA_SUSCHA_RD_009 grau-transparent	1		44	15	155	140	PSU	170°C
142O Deckel FY_SUSCHA_RD_009 grau-transparent	1		32	14	155	139	PP	80°C	



	V139 PR_Suppenschale 0,31 ltr. mit Griff	6	0,25	315	60	383	100		
	passende Kunststoffdeckel:								
	042O Deckel AA_SUSCHA_031_003 grau-transparent	1		22	14	150	100	PSU	170°C
104O Deckel GR_SUSCHA_031_003 warm grey	1		22	14	150	100	PBT	170°C	



ARTIKELVERZEICHNIS

ARTIKELNUMMER	VE	Inhalt in ltr.	Gewicht in gr.	Höhe in mm	Stapelhöhe 11 St. in mm	Ø in mm	Material	Temp. bis
---------------	----	----------------	----------------	------------	-------------------------	---------	----------	-----------

SUPPENSCHALEN

	V151 PR_Suppschale 0,31 ltr.	6	0,31	230	56	425	102		
	passende Kunststoffdeckel:								
	027O Deckel FK_SUSCHA_031_005 grau	1		27	12	126	105	PP	83°C
	084O Deckel HK_SUSCHA_031_037 grau	1		41	15	160	109	TPE-S	140°C
	181O Deckel GR_SUSCHA_031_005 warm grey	1		30	12	126	105	PBT	170°C



027O



084O



181O

	V161 PR_Suppschale 0,40 ltr.	6	0,40	235	65	232	119		
	passende Kunststoffdeckel:								
	021O Deckel FN_SUSCHA_040_006 dunkelbraun	1		45	13	146	126	PP	83°C
	028O Deckel FK_SUSCHA_040_006 grau	1		41	13	146	126	PP	83°C
	036O Deckel FL_SUSCHA_040_006 flieder	1		42	13	146	126	PP	83°C
	079O Deckel GR_SUSCHA_040_006 warm grey	1		62	13	144	126	PBT	170°C



021O



028O



036O



079O

	V170 PR_Suppschale 0,45 ltr.	4	0,47	305	58	347	125		
	passender Kunststoffdeckel:								
	099O Deckel FK_SUSCHA_128_044 grau	1		60	17	182	128	PP	110°C



099O

	V187 PR_Suppschale 0,30 ltr. mit Hkl.	6	0,30	230	54	514	99		
	passende Kunststoffdeckel:								
	042O Deckel AA_SUSCHA_031_003 grau-transparent	1		22	14	150	100	PSU	170°C
	104O Deckel GR_SUSCHA_031_003 warm grey	1		22	14	150	100	PBT	170°C



042O



104O

	V201 IM_Suppschale 0,40 ltr. mit Griff	6	0,36	270	61	243	122		
	passende Kunststoffdeckel:								
	021O Deckel FN_SUSCHA_040_006 dunkelbraun	1		45	13	146	126	PP	83°C
	028O Deckel FK_SUSCHA_040_006 grau	1		41	13	146	126	PP	83°C
	036O Deckel FL_SUSCHA_040_006 flieder	1		42	13	146	126	PP	83°C
	079O Deckel GR_SUSCHA_040_006 warm grey	1		62	13	144	126	PBT	170°C



021O



028O



036O



079O

PORZELLAN & KUNSTSTOFFDECKEL

ARTIKELNUMMER	VE	Inhalt in ltr.	Gewicht in gr.	Höhe in mm	Stapelhöhe 11 St. in mm	Ø in mm	Material	Temp. bis
---------------	----	----------------	----------------	------------	-------------------------	---------	----------	-----------

SUPPENSCHALEN



V202 IM_Suppenschale 0,45 ltr. mit Griff	4	0,45	295	54	228	137		
passende Kunststoffdeckel:								
0070 Deckel AA_SUSCHA_050_007 grau-transparent	1		53	13	134	140	PSU	170°C
0220 Deckel FN_SUSCHA_050_008 dunkelbraun	1		60	14	152	139	PP	83°C
0290 Deckel FK_SUSCHA_050_008 grau	1		58	14	152	139	PP	83°C
0370 Deckel FL_SUSCHA_050_008 flieder	1		58	14	152	139	PP	83°C
0800 Deckel GR_SUSCHA_050_008 warm grey	1		81	14	153	139	PBT	170°C
0860 Deckel HK_SUSCHA_050_039 grau	1		68	15	170	140	TPE-S	140°C
1130 Deckel FV_SUSCHA_050_007 glasklar-milchig	1		32	13	128	139	PP	88°C
1560 Deckel FY_SUSCHA_050_007 grau-transparent	1		45	13	134	140	PP	80°C

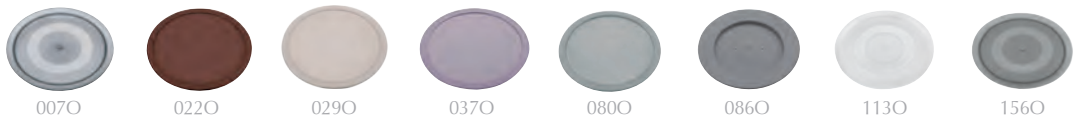

V203 IM_Suppenschale 0,50 ltr. mit Griff	6	0,50	340	65	240	137		
passende Kunststoffdeckel:								
0070 Deckel AA_SUSCHA_050_007 grau-transparent	1		53	13	134	140	PSU	170°C
0220 Deckel FN_SUSCHA_050_008 dunkelbraun	1		60	14	152	137	PP	83°C
0290 Deckel FK_SUSCHA_050_008 grau	1		58	14	152	139	PP	83°C
0370 Deckel FL_SUSCHA_050_008 flieder	1		58	14	152	139	PP	83°C
0800 Deckel GR_SUSCHA_050_008 warm grey	1		81	14	153	139	PBT	170°C
0860 Deckel HK_SUSCHA_050_039 grau	1		68	15	170	140	TPE-S	140°C
1130 Deckel FV_SUSCHA_050_007 glasklar-milchig	1		32	13	128	139	PP	88°C
1560 Deckel FY_SUSCHA_050_007 grau-transparent	1		45	13	134	140	PP	80°C



V204 IM_Suppenschale 0,90 ltr. mit Griff	4	0,90	595	68	290	172		
passende Kunststoffdeckel:								
0230 Deckel FN_SUSCHA_090_010 dunkelbraun	1		77	12	121	180	PP	83°C
0300 Deckel FK_SUSCHA_090_010 grau	1		79	12	121	180	PP	83°C
0380 Deckel FL_SUSCHA_090_010 flieder	1		79	12	121	180	PP	83°C
1480 Deckel GR_Eintopf1,0_010 warm grey	1		110	12	122	178	PBT	170°C



V205 IM_Suppenschale 0,45 ltr.	4	0,45	290	54	205	139		
passende Kunststoffdeckel:								
0460 Deckel AA_SUSCHA_RD_009 grau-transparent	1		44	15	155	140	PSU	170°C
1420 Deckel FY_SUSCHA_RD_009 grau-transparent	1		32	14	155	139	PP	80°C



V251 IM_Suppenschale 0,31 ltr.	6	0,31	250	56	424	106		
passende Kunststoffdeckel:								
0270 Deckel FK_SUSCHA_031_005 grau	1		27	12	126	105	PP	83°C
0840 Deckel HK_SUSCHA_031_037 grau	1		41	15	160	109	TPE-S	140°C
1810 Deckel GR_SUSCHA_031_005 warm grey	1		30	12	126	105	PBT	170°C



ARTIKELVERZEICHNIS

ARTIKELNUMMER	VE	Inhalt in ltr.	Gewicht in gr.	Höhe in mm	Stapelhöhe 11 St. in mm	Ø in mm	Material	Temp. bis
---------------	----	----------------	----------------	------------	-------------------------	---------	----------	-----------

SUPPENSCHALEN

	V501 PR_Suppenschale 0,30 ltr. mit Griff	6	0,30	305	55	255	115		
---	---	---	------	-----	----	-----	-----	--	--

	V515 PR_Suppenschale 0,40 ltr. mit Griff	6	0,40	370	59	290	127		
	passender Kunststoffdeckel: 1490 Deckel AA_SUSCHASCHW_068 grau-transparent	1		35	11	111	125	PSU	170°C



1490

	V531 PR_Suppenschale schwappsicher 0,45 ltr.	6	0,48	295	64	404	122		
	passende Kunststoffdeckel:								
	021O Deckel FN_SUSCHA_040_006 dunkelbraun	1		45	13	146	126	PP	83°C
	028O Deckel FK_SUSCHA_040_006 grau	1		41	13	146	126	PP	83°C
	036O Deckel FL_SUSCHA_040_006 flieder	1		42	13	146	126	PP	83°C
	079O Deckel GR_SUSCHA_040_006 warm grey	1		62	13	144	126	PBT	170°C
	1490 Deckel AA_SUSCHASCHW_068 grau-transparent	1		35	11	111	125	PSU	170°C



021O



028O



036O



079O



1490

	V548 PR_Suppenschale schwappsicher 0,45 ltr.	4	0,47	300	56	360	125		
	passender Kunststoffdeckel: 099O Deckel FK_SUSCHA_128_044 grau	1		60	17	182	128	PP	110°C



099O

	V549 PR_Suppenschale 0,45 ltr.	4	0,45	290	56	360	125		
	passender Kunststoffdeckel: 099O Deckel FK_SUSCHA_128_044 grau	1		60	17	182	128	PP	110°C



099O

	V790 PR_Suppenschale 0,53 ltr.	6	0,53	305	56	265	136		
	passende Kunststoffdeckel:								
	046O Deckel AA_SUSCHA_RD_009 grau-transparent	1		44	15	155	140	PSU	170°C
	086O Deckel HK_SUSCHA_050_039 grau	1		68	15	170	140	TPE-S	140°C
	142O Deckel FY_SUSCHA_RD_009 grau-transparent	1		32	14	155	139	PP	80°C



046O



086O



142O

PORZELLAN & KUNSTSTOFFDECKEL

ARTIKELNUMMER	VE	Inhalt in ltr.	Gewicht in gr.	Höhe in mm	Stapelhöhe 11 St. in mm	Ø in mm	Material	Temp. bis
---------------	----	----------------	----------------	------------	-------------------------	---------	----------	-----------

EINTOPFSCHALEN

	V110 PR_Eintopfschale 0,95 ltr.	2	0,90	615	53	482	175		
	passende Kunststoffdeckel:								
	023O Deckel FN_SUSCHA_090_010 dunkelbraun	1		77	12	121	180	PP	83°C
	030O Deckel FK_SUSCHA_090_010 grau	1		79	12	121	180	PP	83°C
	038O Deckel FL_SUSCHA_090_010 flieder	1		79	12	121	180	PP	83°C
	148O Deckel GR_Eintopf1,0_010 warm grey	1		110	12	122	178	PBT	170°C



023O



030O



038O



148O

	V111 PR_Eintopfschale 1,00 ltr.	4	1,00	590	63	446	168		
---	--	----------	-------------	------------	-----------	------------	------------	--	--

	V112 PR_Eintopfschale 1,10 ltr.	4	1,10	615	62	290	194		
	passende Kunststoffdeckel:								
	024O Deckel FN_EINTOPF1,1_012 dunkelbraun	1		114	15	155	201	PP	83°C
	031O Deckel FK_EINTOPF1,1_012 grau	1		112	15	155	201	PP	83°C
	039O Deckel FL_EINTOPF1,1_012 flieder	1		115	15	155	201	PP	83°C
	054O Deckel AA_EINTOPF1,1_011 grau-transparent	1		97	12	132	200	PSU	170°C
	081O Deckel GR_EINTOPF1,1_012 warm grey	1		164	14	157	201	PBT	170°C
	155O Deckel FY_EINTOPF1,1_011 grau-transparent	1		100	12	132	200	PP	80°C



024O



031O



039O



054O



081O



155O

	V113 PR_Eintopfschale 1,20 ltr.	4	1,25	650	57	270	212		
	passende Kunststoffdeckel:								
	025O Deckel FN_EINTOPF1,2_013 dunkelbraun	1		124	13	147	218	PP	83°C
	032O Deckel FK_EINTOPF1,2_013 grau	1		125	13	147	218	PP	83°C
	040O Deckel FL_EINTOPF1,2_013 flieder	1		128	13	147	218	PP	83°C
	132O Deckel GR_EINTOPF1,2_013 warm grey	1		178	15	160	218	PBT	170°C



025O



032O



040O



132O

	V165 PR_Eintopfeller 23 cm	6	1,25	650	43	263	230		
	passende Kunststoffdeckel:								
	057O Deckel AA_TELLER_230_015 grau-transparent	1		148	41	161	238	PSU	170°C
	083O Deckel GR_TELLER_230_015 warm grey	1		156	40	160	235	PBT	170°C
	100O Deckel IK_TELLER_230_045 grau	1		193	40	180	239	PBT	160°C
	122O Deckel FV_TELLER_230_045 glasklar-milchig	1		86	40	150	239	PP	88°C
	151O Deckel FY_TELLER_230_015 grau-transparent	1		150	41	161	238	PP	80°C



057O



083O



100O



122O



151O

ARTIKELNUMMER	VE	Inhalt in ltr.	Gewicht in gr.	Höhe in mm	Stapelhöhe 11 St. in mm	Ø in mm	Material	Temp. bis
---------------	----	----------------	----------------	------------	-------------------------	---------	----------	-----------

EINTOPFSCHALEN

	V210 IM_Eintopfschale 0,90 ltr.	2	0,90	615	54	489	177		
	passende Kunststoffdeckel:								
	023O Deckel FN_SUSCHA_090_010 dunkelbraun	1		77	12	121	180	PP	83°C
	030O Deckel FK_SUSCHA_090_010 grau	1		79	12	121	180	PP	83°C
	038O Deckel FL_SUSCHA_090_010 flieder	1		79	12	121	180	PP	83°C
	148O Deckel GR_Eintopf1,0_010 warm grey	1		110	12	122	178	PBT	170°C



023O



030O



038O



148O

	V212 IM_Eintopfschale 1,10 ltr.	4	1,20	615	61	285	194		
	passende Kunststoffdeckel:								
	024O Deckel FN_EINTOPF1,1_012 dunkelbraun	1		114	15	155	201	PP	83°C
	031O Deckel FK_EINTOPF1,1_012 grau	1		112	15	155	201	PP	83°C
	039O Deckel FL_EINTOPF1,1_012 flieder	1		115	15	155	201	PP	83°C
	054O Deckel AA_EINTOPF1,1_011 grau-transparent	1		97	12	132	200	PSU	170°C
	081O Deckel GR_EINTOPF1,1_012 warm grey	1		164	14	157	201	PBT	170°C
	155O Deckel FY_EINTOPF1,1_011 grau-transparent	1		100	12	132	200	PP	80°C



024O



031O



039O



054O



081O



155O

	V547 PR_Eintopfschale niedrig 20 cm	4	1,00	545	46	250	202		
---	--	----------	-------------	------------	-----------	------------	------------	--	--

	V591 PR_Eintopf 1,00 ltr.	4	1,00	475	49	256	192		
	passende Kunststoffdeckel:								
	024O Deckel FN_EINTOPF1,1_012 dunkelbraun	1		114	15	155	201	PP	83°C
	031O Deckel FK_EINTOPF1,1_012 grau	1		112	15	155	201	PP	83°C
	039O Deckel FL_EINTOPF1,1_012 flieder	1		115	15	155	201	PP	83°C
	081O Deckel GR_EINTOPF1,1_012 warm grey	1		164	14	157	201	PBT	170°C
	155O Deckel FY_EINTOPF1,1_011 grau-transparent	1		100	12	132	200	PP	80°C



024O



031O



039O



081O



155O

PORZELLAN & KUNSTSTOFFDECKEL

ARTIKELNUMMER	VE	Inhalt in ltr.	Gewicht in gr.	Höhe in mm	Stapelhöhe 11 St. in mm	Ø in mm	Material	Temp. bis
---------------	----	----------------	----------------	------------	-------------------------	---------	----------	-----------

TELLER

	V114 PR_Teller halbtief 25,5 cm	6		815	29	130	255			
	passende Kunststoffdeckel:									
	056O Deckel AA_TELLER_255_016 grau-transparent	1		186	41	174	265	PSU	170°C	
	112O Deckel FV_TELLER_255_049 glasklar-milchig	1		134	40	164	264	PP	88°C	
	131O Deckel GR_TELLER_255_019 warm grey	1		190	40	160	262	PBT	170°C	
	145O Deckel FY_TELLER_255_016 grau-transparent	1		134	40	164	263	PP	80°C	
	160O Deckel GR_TE_HOCH_255_016 warm grey	1		205	51	231	268	PBT	170°C	
	167O Deckel MA_TELLER_255_016 grau-transparent	1		165	41	160	265	PA	140°C	



	V115 PR_Teller flach 25,5 cm	6		760	25	143	257			
	passende Kunststoffdeckel:									
	056O Deckel AA_TELLER_255_016 grau-transparent	1		186	41	174	265	PSU	170°C	
	087O Deckel IK_TELLER_255_040 grau	1		230	41	174	269	PBT	160°C	
	089O Deckel EE_TELLER_255_040 glasklar	1		207	41	175	270	PC	110°C	
	112O Deckel FV_TELLER_255_049 glasklar-milchig	1		134	40	164	264	PP	88°C	
	131O Deckel GR_TELLER_255_019 warm grey	1		190	40	160	262	PBT	170°C	
	145O Deckel FY_TELLER_255_016 grau-transparent	1		134	40	164	263	PP	80°C	
160O Deckel GR_TE_HOCH_255_016 warm grey	1		205	51	231	268	PBT	170°C		
167O Deckel MA_TELLER_255_016 grau-transparent	1		165	41	160	265	PA	140°C		



	V150 PR_Teller flach 23 cm	6		595	25	162	231			
	passende Kunststoffdeckel:									
	057O Deckel AA_TELLER_230_015 grau-transparent	1		148	41	161	238	PSU	170°C	
	083O Deckel GR_TELLER_230_015 warm grey	1		156	40	160	235	PBT	170°C	
	122O Deckel FV_TELLER_230_045 glasklar-milchig	1		86	40	150	239	PP	88°C	
	130O Deckel AA_TE_HOCH_230_061 grau-transparent	1		156	51	190	237	PSU	170°C	
	147O Deckel GR_TE_HOCH_230_067 warm grey	1		156	51	161	236	PBT	170°C	
	151O Deckel FY_TELLER_230_015 grau-transparent	1		150	41	161	238	PP	80°C	
171O Deckel MA_TELLER_230_015 grau-transparent	1		115	40	170	241	PA	140°C		



	V162 PR_Teller flach 26 cm Coup	6		630	28	130	258			
	passende Kunststoffdeckel:									
	087O Deckel IK_TELLER_255_040 grau	1		230	41	174	269	PBT	160°C	
089O Deckel EE_TELLER_255_040 glasklar	1		207	41	175	270	PC	110°C		



	V164 PR_Teller halbtief 26 cm Coup	6		680	34	155	260			
	passende Kunststoffdeckel:									
	056O Deckel AA_TELLER_255_016 grau-transparent	1		186	41	174	265	PSU	170°C	
	087O Deckel IK_TELLER_255_040 grau	1		230	41	174	269	PBT	160°C	
	089O Deckel EE_TELLER_255_040 glasklar	1		207	41	175	270	PC	110°C	
167O Deckel MA_TELLER_255_016 grau-transparent	1		165	41	160	265	PA	140°C		



ARTIKELVERZEICHNIS

ARTIKELNUMMER	VE	Inhalt in ltr.	Gewicht in gr.	Höhe in mm	Stapelhöhe 11 St. in mm	Ø in mm	Material	Temp. bis
---------------	----	----------------	----------------	------------	-------------------------	---------	----------	-----------

TELLER

	V174 PR_Teller flach 22,5 cm	6	645	25	142	225		
	passende Kunststoffdeckel:							
	057O Deckel AA_TELLER_230_015 grau-transparent	1	148	41	161	238	PSU	170°C
	083O Deckel GR_TELLER_230_015 warm grey	1	156	40	160	235	PBT	170°C
	122O Deckel FV_TELLER_230_045 glasklar-milchig	1	86	40	150	239	PP	88°C
	147O Deckel GR_TE_HOCH_230_067 warm grey	1	156	51	161	236	PBT	170°C
	151O Deckel FY_TELLER_230_015 grau-transparent	1	150	41	161	238	PP	80°C
	171O Deckel MA_TELLER_230_015 grau-transparent	1	115	40	170	241	PA	140°C



057O



083O



122O



147O



151O



171O

	V215 IM_Teller flach 25,5 cm	6	730	26	133	255		
	passende Kunststoffdeckel:							
	056O Deckel AA_TELLER_255_016 grau-transparent	1	186	41	174	265	PSU	170°C
	087O Deckel IK_TELLER_255_040 grau	1	230	41	174	269	PBT	160°C
	089O Deckel EE_TELLER_255_040 glasklar	1	207	41	175	270	PC	110°C
	112O Deckel FV_TELLER_255_049 glasklar-milchig	1	134	40	164	264	PP	88°C
	131O Deckel GR_TELLER_255_019 warm grey	1	190	40	160	262	PBT	170°C
	145O Deckel FY_TELLER_255_016 grau-transparent	1	134	40	164	263	PP	80°C
	160O Deckel GR_TE_HOCH_255_016 warm grey	1	205	51	231	268	PBT	170°C
	167O Deckel MA_TELLER_255_016 grau-transparent	1	165	41	160	265	PA	140°C



056O



087O



089O



112O



131O



145O



160O



167O

	V276 IM_Teller halbtief 25,5 cm	6	740	31	143	255		
	passende Kunststoffdeckel:							
	056O Deckel AA_TELLER_255_016 grau-transparent	1	186	41	174	265	PSU	170°C
	087O Deckel IK_TELLER_255_040 grau	1	230	41	174	269	PBT	160°C
	089O Deckel EE_TELLER_255_040 glasklar	1	207	41	175	270	PC	110°C
	167O Deckel MA_TELLER_255_016 grau-transparent	1	165	41	160	265	PA	140°C



056O



087O



089O



167O

	V509 PR_Teller flach 19,7 cm	6	320	18	98	199		
	passende Kunststoffdeckel:							
	053O Deckel AA_TELLER_200_014 grau-transparent	1	146	56	168	213	PSU	170°C
125O Deckel FV_TELLER_200_014 glasklar-milchig	1	106	55	155	211	PP	88°C	



053O



125O

	V545 PR_Teller rund 24 cm	6	685	25	140	238		

	V555 PR_Teller eckig 1-tlg. 22x16 cm	6	520	22	113	220x160		
	passender Kunststoffdeckel:							
137O Deckel FV_Teller2216_064 glasklar-milchig	1	130	56	180	229x168	PP	110°C	



137O

PORZELLAN & KUNSTSTOFFDECKEL

ARTIKELNUMMER	VE	Inhalt in ltr.	Gewicht in gr.	Höhe in mm	Stapelhöhe 11 St. in mm	Ø in mm	Material	Temp. bis
---------------	----	----------------	----------------	------------	-------------------------	---------	----------	-----------

TELLER

	V730 PR_Teller flach 23 cm	6		670	24	160	229			
	passende Kunststoffdeckel:									
	057O Deckel AA_TELLER_230_015 grau-transparent	1		148	41	161	238	PSU	170°C	
	083O Deckel GR_TELLER_230_015 warm grey	1		156	40	160	235	PBT	170°C	
	100O Deckel IK_TELLER_230_045 grau	1		193	40	180	239	PBT	160°C	
	122O Deckel FV_TELLER_230_045 glasklar-milchig	1		86	40	150	239	PP	88°C	
	130O Deckel AA_TE_HOCH_230_061 grau-transparent	1		156	51	190	237	PSU	170°C	
	147O Deckel GR_TE_HOCH_230_067 warm grey	1		156	51	161	236	PBT	170°C	
	151O Deckel FY_TELLER_230_015 grau-transparent	1		150	41	161	238	PP	80°C	
	171O Deckel MA_TELLER_230_015 grau-transparent	1		115	40	170	241	PA	140°C	



	V770 PR_Teller flach 20,5 cm	4		486	21	183	204			
	passende Kunststoffdeckel:									
	053O Deckel AA_TELLER_200_014 grau-transparent	1		146	56	168	213	PSU	170°C	
125O Deckel FV_TELLER_200_014 glasklar-milchig	1		106	55	155	211	PP	88°C		



	V780 PR_Teller 3-eckig 23,8 cm	6		525	26	126	238			
	passende Kunststoffdeckel:									
	043O Deckel AA_TELLER_3EC_034 grau-transparent	1		163	41	167	247	PSU	170°C	
141O Deckel FY_TELLER_3EC_034 grau-transparent	1		116	40	167	246	PP	80°C		



	V781 PR_Teller 4-eckig 24 cm	6		485	27	125	211x211			
	passende Kunststoffdeckel:									
	044O Deckel AA_TELLER_4EC_025 grau-transparent	1		151	41	170	223x223	PSU	170°C	
	109O Deckel DD_TELLER_4EC_025 transparent	1		141	42	170	223x223	PC	100°C	
163O Deckel GR_TELLER_4EC_025 warm grey	1		150	40	170	220x220	PBT	170°C		



	V782 PR_Teller rund 23 cm	6		540	28	118	230			
	passende Kunststoffdeckel:									
	057O Deckel AA_TELLER_230_015 grau-transparent	1		148	41	161	238	PSU	170°C	
	083O Deckel GR_TELLER_230_015 warm grey	1		156	40	160	235	PBT	170°C	
	100O Deckel IK_TELLER_230_045 grau	1		193	40	180	238	PBT	160°C	
	122O Deckel FV_TELLER_230_045 glasklar-milchig	1		86	40	150	239	PP	88°C	
	130O Deckel AA_TE_HOCH_230_061 grau-transparent	1		156	51	190	237	PSU	170°C	
	151O Deckel FY_TELLER_230_015 grau-transparent	1		150	41	161	238	PP	80°C	
	171O Deckel MA_TELLER_230_015 grau-transparent	1		115	40	170	241	PA	140°C	



ARTIKELVERZEICHNIS

ARTIKELNUMMER	VE	Inhalt in ltr.	Gewicht in gr.	Höhe in mm	Stapelhöhe 11 St. in mm	Ø in mm	Material	Temp. bis
---------------	----	----------------	----------------	------------	-------------------------	---------	----------	-----------

PLATTEN

	V119 PR-Platte rund 3-tlg. 25,5 cm	2		820	29	136	255		
	passende Kunststoffdeckel:								
	056O Deckel AA_TELLER_255_016 grau-transparent	1		186	41	174	265	PSU	170°C
	112O Deckel FV_TELLER_255_049 glasklar-milchig	1		134	40	164	264	PP	88°C
	131O Deckel GR_TELLER_255_019 warm grey	1		190	40	160	262	PBT	170°C
	145O Deckel FY_TELLER_255_016 grau-transparent	1		134	40	164	263	PP	80°C
	160O Deckel GR_TE_HOCH_255_016 warm grey	1		205	51	231	268	PBT	170°C
	167O Deckel MA_TELLER_255_016 grau-transparent	1		165	41	160	265	PA	140°C



056O



112O



131O



145O



160O



167O

	V120 PR-Platte rund 3-tlg. 25,5 cm Coup	2		735	31	128	260		
	passende Kunststoffdeckel:								
	056O Deckel AA_TELLER_255_016 grau-transparent	1		186	41	174	265	PSU	170°C
	087O Deckel IK_TELLER_255_040 grau	1		230	41	174	269	PBT	160°C
089O Deckel EE_TELLER_255_040 glasklar	1		207	41	175	270	PC	110°C	



056O



087O



089O

	V125 PR-Platte eckig 1-tlg. 20x20 cm	2		600	25	158	199x199		
	passender Kunststoffdeckel:								
049O Deckel AA_PLATTE2020_023 grau-transparent	1		158	46	170	209x209	PSU	170°C	



049O

	V126 PR-Platte eckig 1-tlg. 18x18 cm	2		470	23	134	185x185		
	passender Kunststoffdeckel:								
117O Deckel FV_PLATTE1818_053 glasklar-milchig	1		76	51	111	184x184	FV	67°C	



117O

	V128 PR-Platte eckig 1-tlg. 16x11 cm	2		290	20	122	161x116		
	passender Kunststoffdeckel:								
107O Deckel FV_PLATTE1611_030 glasklar-milchig	1		85	51	175	168x124	PP	110°C	



107O

	V138 PR-Platte rund 3-tlg. 26 cm	2		880	30	148	260		
	passende Kunststoffdeckel:								
	056O Deckel AA_TELLER_255_016 grau-transparent	1		186	41	174	265	PSU	170°C
	087O Deckel IK_TELLER_255_040 grau	1		230	41	174	269	PBT	160°C
	089O Deckel EE_TELLER_255_040 glasklar	1		207	41	175	270	PC	110°C



056O



087O



089O

PORZELLAN & KUNSTSTOFFDECKEL

ARTIKELNUMMER	VE	Inhalt in ltr.	Gewicht in gr.	Höhe in mm	Stapelhöhe 11 St. in mm	Ø in mm	Material	Temp. bis
---------------	----	----------------	----------------	------------	-------------------------	---------	----------	-----------

PLATTEN

	V147 PR_Teller rund 2-tlg. 23 cm	6		740	25	233	232			
	passende Kunststoffdeckel:									
	057O Deckel AA_TELLER_230_015 grau-transparent	1		148	41	161	238	PSU	170°C	
	083O Deckel GR_TELLER_230_015 warm grey	1		156	40	160	235	PBT	170°C	
	122O Deckel FV_TELLER_230_045 glasklar-milchig	1		86	40	150	239	PP	88°C	
	130O Deckel AA_TE_HOCH_230_061 grau-transparent	1		156	51	190	237	PSU	170°C	
	151O Deckel FY_TELLER_230_015 grau-transparent	1		150	41	161	238	PP	80°C	
	171O Deckel MA_TELLER_230_015 grau-transparent	1		115	40	170	241	PA	140°C	



	V182 PR_Platte eckig 1-tlg. 17,5x11 cm	6		340	23	152	176x114		
	passender Kunststoffdeckel:								
	106O Deckel KE_SCHALE1117_048 glasklar	1		85	33	165	182x120	PET	65°C



	V186 PR_Teller rund 3-tlg. 23 cm	6		780	26	233	231			
	passende Kunststoffdeckel:									
	057O Deckel AA_TELLER_230_015 grau-transparent	1		148	41	161	238	PSU	170°C	
	083O Deckel GR_TELLER_230_015 warm grey	1		156	40	160	235	PBT	170°C	
	100O Deckel IK_TELLER_230_045 grau	1		193	40	180	239	PBT	160°C	
	122O Deckel FV_TELLER_230_045 glasklar-milchig	1		86	40	150	239	PP	88°C	
	130O Deckel AA_TE_HOCH_230_061 grau-transparent	1		156	51	190	237	PSU	170°C	
	151O Deckel FY_TELLER_230_015 grau-transparent	1		150	41	161	238	PP	80°C	
	171O Deckel MA_TELLER_230_015 grau-transparent	1		115	40	170	241	PA	140°C	



	V219 IM_Platte rund 3-tlg. 25,5 cm	2		750	30	126	257			
	passende Kunststoffdeckel:									
	056O Deckel AA_TELLER_255_016 grau-transparent	1		186	41	174	265	PSU	170°C	
	087O Deckel IK_TELLER_255_040 grau	1		230	41	174	269	PBT	160°C	
	089O Deckel EE_TELLER_255_040 glasklar	1		207	41	175	270	PC	110°C	
	160O Deckel GR_TE_HOCH_255_016 warm grey	1		205	51	231	268	PBT	170°C	
	167O Deckel MA_TELLER_255_016 grau-transparent	1		165	41	160	265	PA	140°C	



	V260 IM_Platte rund 3-tlg. 3/3 25,5 cm	2		825	31	143	257			
	passende Kunststoffdeckel:									
	087O Deckel IK_TELLER_255_040 grau	1		230	41	174	269	PBT	160°C	
	089O Deckel EE_TELLER_255_040 glasklar	1		207	41	175	270	PC	110°C	
	167O Deckel MA_TELLER_255_016 grau-transparent	1		165	41	160	265	PA	140°C	



ARTIKELVERZEICHNIS

ARTIKELNUMMER	VE	Inhalt in ltr.	Gewicht in gr.	Höhe in mm	Stapelhöhe 11 St. in mm	Ø in mm	Material	Temp. bis
---------------	----	----------------	----------------	------------	-------------------------	---------	----------	-----------

PLATTEN

	V295 IM-Platte rund 2-tlg. 25,5 cm	2		800	30	141	255		
	passende Kunststoffdeckel:								
	056O Deckel AA_TELLER_255_016 grau-transparent	1		186	41	174	265	PSU	170°C
	087O Deckel IK_TELLER_255_040 grau	1		230	41	174	269	PBT	160°C
	089O Deckel EE_TELLER_255_040 glasklar	1		207	41	175	270	PC	110°C
	112O Deckel FV_TELLER_255_049 glasklar-milchig	1		134	40	164	264	PP	88°C
	131O Deckel GR_TELLER_255_019 warm grey	1		190	40	160	262	PBT	170°C
	145O Deckel FY_TELLER_255_016 grau-transparent	1		134	40	164	263	PP	80°C
	160O Deckel GR_TE_HOCH_255_016 warm grey	1		205	51	231	268	PBT	170°C
	167O Deckel MA_TELLER_255_016 grau-transparent	1		165	41	160	265	PA	140°C



	V504 PR-Platte eckig 1-tlg. 14x8 cm	2		200	20	120	141x87		
---	--	----------	--	------------	-----------	------------	---------------	--	--

	V508 PR-Platte eckig 1-tlg. 17x17 cm	2		485	21	148	171x171		
---	---	----------	--	------------	-----------	------------	----------------	--	--

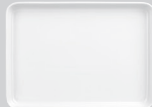
	V554 PR-Platte eckig 1-tlg. 22x16 cm	6		615	22	155	220x160		
passender Kunststoffdeckel:									
137O Deckel FV_Teller2216_064 glasklar-milchig	1		130	56	180	229x168	PP	110°C	



137O

	V556 PR-Platte eckig 1-tlg. 16x11 cm	6		290	22	154	160x110		
passende Kunststoffdeckel:									
107O Deckel FV_PLATTE1611_030 glasklar-milchig	1		85	51	175	168x124	PP	110°C	
136O Deckel FV_Schale1611_063 glasklar-milchig	1		46	27	137	160x110	PP	110°C	
153O Deckel FV_Pla1611_ho_070 glasklar-milchig	1		68	53	133	170x118	PP	110°C	
158O Deckel EE_Pla1611_ho_070 glasklar	1		84	53	133	170x118	PC	80°C	



107O

136O

153O

158O

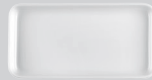
	V563 PR-Platte eckig 1-tlg. 22x11 cm	6		440	22	158	220x110		
---	---	----------	--	------------	-----------	------------	----------------	--	--

PORZELLAN & KUNSTSTOFFDECKEL

ARTIKELNUMMER	VE	Inhalt in ltr.	Gewicht in gr.	Höhe in mm	Stapelhöhe 11 St. in mm	Ø in mm	Material	Temp. bis
---------------	----	----------------	----------------	------------	-------------------------	---------	----------	-----------

PLATTEN

	V731 PR_Teller rund 2-tlg. 23 cm	6		655	25	163	230		
	passende Kunststoffdeckel:								
	0570 Deckel AA_TELLER_230_015 grau-transparent	1		148	41	161	238	PSU	170°C
	0830 Deckel GR_TELLER_230_015 warm grey	1		156	40	160	235	PBT	170°C
	1000 Deckel IK_TELLER_230_045 grau	1		193	40	180	239	PBT	160°C
	1220 Deckel FV_TELLER_230_045 glasklar-milchig	1		86	40	150	239	PP	88°C
	1300 Deckel AA_TE_HOCH_230_061 grau-transparent	1		156	51	190	237	PSU	170°C
	1470 Deckel GR_TE_HOCH_230_067 warm grey	1		156	51	161	236	PBT	170°C
	1510 Deckel FY_TELLER_230_015 grau-transparent	1		150	41	161	238	PP	80°C
	1710 Deckel MA_TELLER_230_015 grau-transparent	1		115	40	170	241	PA	140°C



0570 0830 1000 1220 1300 1470 1510 1710

	V788 PR_Teller 4-eckig 2-tlg. 24 cm	6		635	28	127	208x208		
	passende Kunststoffdeckel:								
	0440 Deckel AA_TELLER_4EC_025 grau-transparent	1		151	41	170	223x223	PSU	170°C
	1090 Deckel DD_TELLER_4EC_025 transparent	1		141	42	170	223x223	PC	100°C
1630 Deckel GR_TELLER_4EC_025 warm grey	1		150	40	170	220x220	PBT	170°C	



0440 1090 1630

	V789 PR_Teller 4-eckig 2-tlg. 24 cm	6		595	26	121	211x211		
	passende Kunststoffdeckel:								
	0440 Deckel AA_TELLER_4EC_025 grau-transparent	1		151	41	170	223x223	PSU	170°C
	1090 Deckel DD_TELLER_4EC_025 transparent	1		141	42	170	223x223	PC	100°C
1630 Deckel GR_TELLER_4EC_025 warm grey	1		150	40	170	220x220	PBT	170°C	



0440 1090 1630

SALAT- und BEILAGENSCHALEN

	V106 MA_Salatschale rund 13 cm	4	0,37	230	43	235	133		
	passende Kunststoffdeckel:								
	0070 Deckel AA_SUSCHA_050_007 grau-transparent	1		53	13	134	140	PSU	170°C
	0220 Deckel FN_SUSCHA_050_008 dunkelbraun	1		60	14	152	137	PP	83°C
	0290 Deckel FK_SUSCHA_050_008 grau	1		58	14	152	139	PP	83°C
	0370 Deckel FL_SUSCHA_050_008 flieder	1		58	14	152	139	PP	83°C
	0800 Deckel GR_SUSCHA_050_008 warm grey	1		81	14	153	139	PBT	170°C
	0860 Deckel HK_SUSCHA_050_039 grau	1		86	15	170	140	TPE-S	140°C
	1130 Deckel FV_SUSCHA_050_007 glasklar-milchig	1		32	13	128	139	PP	88°C
	1560 Deckel FY_SUSCHA_050_007 grau-transparent	1		45	13	134	140	PP	80°C



0070 0220 0290 0370 0800 0860 1130 1560

	V107 MA_Salatschale rund 15 cm	4	0,55	370	48	236	153		
---	---------------------------------------	----------	-------------	------------	-----------	------------	------------	--	--

ARTIKELVERZEICHNIS

ARTIKELNUMMER	VE	Inhalt in ltr.	Gewicht in gr.	Höhe in mm	Stapelhöhe 11 St. in mm	Ø in mm	Material	Temp. bis
---------------	----	----------------	----------------	------------	-------------------------	---------	----------	-----------

SALAT- und BEILAGENSCHALEN

	V108 PR_Salatschale rund 12 cm	4	0,40	255	51	380	120		
	passende Kunststoffdeckel:								
	021O Deckel FN_SUSCHA_040_006 dunkelbraun	1		45	13	146	126	PP	83°C
	028O Deckel FK_SUSCHA_040_006 grau	1		41	13	146	126	PP	83°C
	036O Deckel FL_SUSCHA_040_006 flieder	1		42	13	146	126	PP	83°C
	079O Deckel GR_SUSCHA_040_006 warm grey	1		62	13	144	126	PBT	170°C



021O



028O



036O



079O

	V109 PR_Salatschale rund 15 cm	4	0,70	475	63	472	148		
---	---------------------------------------	----------	-------------	------------	-----------	------------	------------	--	--

	V129 PR_Schale eckig 13x9 cm	2	0,25	220	37	260	129x90		
	passender Kunststoffdeckel:								
	052O Deckel EE_SCHA_1309_028 glasklar	1		61	30	131	124x124	PC	110°C



052O

	V130 PR_Schale eckig 11x8,5 cm	6	0,16	190	36	198	113x83		
	passender Kunststoffdeckel:								
	105O Deckel KE_SCHALE1185_047 glasklar	1		50	33	165	121x89	PET	65°C



105O

	V131 PR_Schale eckig 17,5x11 cm	6	0,38	400	37	209	178x115		
	passender Kunststoffdeckel:								
	106O Deckel KE_SCHALE1117_048 glasklar	1		85	33	165	182x120	PET	65°C



106O

	V133 PR_Salatschale eckig 11x11 cm	4	0,20	195	34	136	110x110		
	passende Kunststoffdeckel:								
	059O Deckel EE_SALAT_EC_K_017 glasklar	1		51	16	180	109x109	PC	110°C
	161O Deckel FV_Schale_1111_072 glasklar-milchig	1		40	27	167	109x109	PP	110°C
	162O Deckel EE_Salat_1111_072 glasklar	1		46	27	167	109x109	PC	80°C



059O



161O



162O

PORZELLAN & KUNSTSTOFFDECKEL

ARTIKELNUMMER	VE	Inhalt in ltr.	Gewicht in gr.	Höhe in mm	Stapelhöhe 11 St. in mm	Ø in mm	Material	Temp. bis
---------------	----	----------------	----------------	------------	-------------------------	---------	----------	-----------

SALAT- und BEILAGENSCHALEN

	V134 PR_Salatschale eckig 10x10 cm	12	0,24	225	50	258	101x101		
	passende Kunststoffdeckel:								
	058O Deckel AA_SALAT_EC12_019 grau-transparent	1		30	27	140	105x105	PSU	170°C
	169O Deckel FY_SALAT_EC12_019 grau-transparent	1		22	27	137	106x106	PP	80°C



058O



169O

	V135 PR_Salatschale eckig 12x12 cm	4	0,26	215	37	163	117x117		
	passende Kunststoffdeckel:								
	051O Deckel EE_SALAT_HOCH_021 glasklar	1		68	31	131	124x124	PC	110°C
	060O Deckel EE_SALAT_EC_G_018 glasklar	1		60	16	180	118x118	PC	110°C
	064O Deckel AA_SALAT_EC15_020 grau-transparent	1		56	27	142	123x123	PSU	170°C



051O



060O

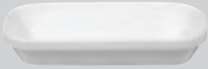

064O

	V171 PR_Schale eckig 20x10 cm	6	0,40	295	35	148	200x100		
	passender Kunststoffdeckel:								
	063O Deckel AA_SALAT_2010_032 grau-transparent	1		77	27	142	205x106	PSU	170°C



063O

	V172 PR_Schale eckig 10x10 cm	6	0,15	135	35	152	100x100		
	passende Kunststoffdeckel:								
	058O Deckel AA_SALAT_EC12_019 grau-transparent	1		30	27	140	105x105	PSU	170°C
	169O Deckel FY_SALAT_EC12_019 grau-transparent	1		22	27	137	106x106	PP	80°C



058O



169O

	V189 PR_Schale eckig 3 tlg. 20x10 cm	6	0,35	310	35	157	202x101		
	passender Kunststoffdeckel:								
	063O Deckel AA_SALAT_2010_032 grau-transparent	1		77	27	142	205x106	PSU	170°C



063O

	V190 PR_Salatschale rund 12 cm	4	0,28	250	41	253	120		
	passende Kunststoffdeckel:								
	021O Deckel FN_SUSCHA_040_006 dunkelbraun	1		45	13	146	126	PP	83°C
	028O Deckel FK_SUSCHA_040_006 grau	1		41	13	146	126	PP	83°C
	036O Deckel FL_SUSCHA_040_006 flieder	1		42	13	146	126	PP	83°C
	079O Deckel GR_SUSCHA_040_006 warm grey	1		62	13	144	126	PBT	170°C



021O



028O



036O



079O

ARTIKELVERZEICHNIS

ARTIKELNUMMER	VE	Inhalt in ltr.	Gewicht in gr.	Höhe in mm	Stapelhöhe 11 St. in mm	Ø in mm	Material	Temp. bis
---------------	----	----------------	----------------	------------	-------------------------	---------	----------	-----------

SALAT- und BEILAGENSCHALEN

	V191 PR_Schale eckig 9x9 cm	6	0,16	160	87	264	89x89		
---	------------------------------------	----------	-------------	------------	-----------	------------	--------------	--	--

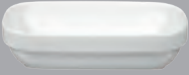
	V192 PR_Salatschale eckig 20x10 cm	6	0,60	395	50	263	200x103		
	passender Kunststoffdeckel: 063O Deckel AA_SALAT_2010_032 grau-transparent	1		77	27	142	205x106	PSU	170°C



063O

	V206 IM_Salatschale rund 13 cm	4	0,38	280	44	236	135		
	passende Kunststoffdeckel:								
	007O Deckel AA_SUSCHA_050_007 grau-transparent	1		53	13	134	140	PSU	170°C
	022O Deckel FN_SUSCHA_050_008 dunkelbraun	1		60	14	152	137	PP	83°C
	029O Deckel FK_SUSCHA_050_008 grau	1		58	14	152	139	PP	83°C
	037O Deckel FL_SUSCHA_050_008 flieder	1		58	14	152	139	PP	83°C
	080O Deckel GR_SUSCHA_050_008 warm grey	1		81	14	153	139	PBT	170°C
	086O Deckel HK_SUSCHA_050_039 grau	1		86	15	170	140	TPE-S	140°C
	113O Deckel FV_SUSCHA_050_007 glasklar-milchig	1		32	13	128	139	PP	88°C
	156O Deckel FY_SUSCHA_050_007 grau-transparent	1		45	13	134	140	PP	80°C



007O



022O



029O



037O



080O



086O



113O



156O

	V207 IM_Salatschale rund 15 cm	4	0,60	350	50	237	155		
---	---------------------------------------	----------	-------------	------------	-----------	------------	------------	--	--

	V232 IM_Salatschale eckig 12x12 cm	4	0,30	310	43	276	117x117		
	passende Kunststoffdeckel:								
	051O Deckel EE_SALAT_HOCH_021 glasklar	1		68	31	131	124x124	PC	110°C
	060O Deckel EE_SALAT_EC_G_018 glasklar	1		60	16	180	118x118	PC	110°C
	064O Deckel AA_SALAT_EC15_020 grau-transparent	1		56	27	142	123x123	PSU	170°C



051O



060O



064O

	V293 IM_Salatschale rund 10 cm	6	0,22	170	42	271	105		
	passende Kunststoffdeckel:								
	027O Deckel FK_SUSCHA_031_005 grau	1		27	12	126	105	PP	83°C
	084O Deckel HK_SUSCHA_031_037 grau	1		41	15	160	109	TPE-S	140°C
	181O Deckel GR_SUSCHA_031_005 warm grey	1		30	12	126	105	PBT	170°C



027O



084O



181O

PORZELLAN & KUNSTSTOFFDECKEL

ARTIKELNUMMER	VE	Inhalt in ltr.	Gewicht in gr.	Höhe in mm	Stapelhöhe 11 St. in mm	Ø in mm	Material	Temp. bis
---------------	----	----------------	----------------	------------	-------------------------	---------	----------	-----------

SALAT- und BEILAGENSCHALEN

	V505 PR_Schale eckig 14x8 cm	6	0,25	260	40	210	141x87		
	passender Kunststoffdeckel: 1340 Deckel FV_Schale1408_029 glasklar-milchig	1		48	31	322	148x99	PP	88°C



1340

	V506 PR_Schale eckig 17x12 cm	6	0,48	410	41	310	171x127		
---	--------------------------------------	----------	-------------	------------	-----------	------------	----------------	--	--

	V507 PR_Schale eckig 8x8 cm	6	0,13	165	40	210	84x84		
---	------------------------------------	----------	-------------	------------	-----------	------------	--------------	--	--

	V514 PR_Salatschale eckig 12x12 cm	4	0,40	275	50	254	118x118		
	passende Kunststoffdeckel:								
	0640 Deckel AA_SALAT_EC15_020 grau-transparent 1540 Deckel FY_SALAT_EC15_020 grau-transparent	1 1		56 60	27 27	142 142	123x123 123x123	PSU PP	170°C 80°C



0640



1540

	V516 PR_Salatschale eckig 12,5x12,5 cm	4	0,33	255	37	197	127x127		
---	---	----------	-------------	------------	-----------	------------	----------------	--	--

	V533 PR_Schale eckig 14x8,5 cm	2	0,40	360	54	395	141x85		
---	---------------------------------------	----------	-------------	------------	-----------	------------	---------------	--	--

	V551 PR_Schale eckig 11x8 cm	6	0,17	190	37	208	110x80		
	passende Kunststoffdeckel:								
	1350 Deckel FV_Schale1108_062 glasklar-milchig	1		26	27	137	110x80	PP	110°C
	1520 Deckel FV_Schale1108_071 glasklar-milchig	1		32	30	110	120x90	PP	110°C
	1570 Deckel EE_Schale1108_071 glasklar	1		40	30	110	119x89	PC	80°C



1350



1520



1570

	V553 PR_Schale eckig 16x11 cm	6	0,36	350	37	208	160x110		
	passende Kunststoffdeckel:								
	1360 Deckel FV_Schale1611_063 glasklar-milchig	1		46	27	137	160x110	PP	110°C
	1530 Deckel FV_Pla1611_ho_070 glasklar-milchig	1		68	53	133	170x118	PP	110°C
	1580 Deckel EE_Pla1611_ho_070 glasklar	1		84	53	133	170x118	PC	80°C



1360



1530



1580

ARTIKELVERZEICHNIS

ARTIKELNUMMER	VE	Inhalt in ltr.	Gewicht in gr.	Höhe in mm	Stapelhöhe 11 St. in mm	Ø in mm	Material	Temp. bis
---------------	----	----------------	----------------	------------	-------------------------	---------	----------	-----------

SALAT- und BEILAGENSCHALEN

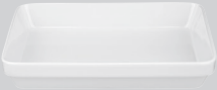
	V557 PR_Schale eckig 22x16 cm	2	0,80	740	38	207	220x160		
	passender Kunststoffdeckel: 137O Deckel FV_Teller2216_064 glasklar-milchig	1		130	56	180	229x168	PP	110°C



137O

	V560 PR_Schale eckig 11x8 cm	6	0,17	200	34	238	113x82		
	passende Kunststoffdeckel: 105O Deckel KE_SCHALE1185_047 glasklar 157O Deckel EE_Schale1108_071 glasklar	1 1		50 40	33 30	165 110	121x89 119x89	PET PC	65°C 80°C



105O



157O

	V562 PR_Schale eckig 11x8 cm hoch	6	0,18	220	47	210	110x80		
	passende Kunststoffdeckel: 135O Deckel FV_Schale1108_062 glasklar-milchig 152O Deckel FV_Schale1108_071 glasklar-milchig 157O Deckel EE_Schale1108_071 glasklar	1 1 1		26 32 40	27 30 30	137 110 110	110x80 120x90 119x89	PP PP PC	110°C 110°C 80°C



135O



152O



157O

	V564 PR_Schale eckig 11x11 cm hoch	4	0,29	285	47	215	110x110		
	passende Kunststoffdeckel: 161O Deckel FV_Schale_1111_072 glasklar-milchig 162O Deckel EE_Salat_1111_072 glasklar	1 1		40 46	27 27	167 167	109x109 109x109	PP PC	110°C 80°C



161O



162O

	V645 PR_Schale eckig 17x10 cm	6	0,24	260	30	135	172x100		
--	--------------------------------------	----------	-------------	------------	-----------	------------	----------------	--	--

	V783 PR_Dessertschale 4-eckig 15 cm	6	0,35	285	49	189	134x134		
	passende Kunststoffdeckel: 045O Deckel AA_DESSERT_EC_024 grau-transparent 143O Deckel FY_DESSERT_EC_024 grau-transparent	1 1		52 36	25 25	123 123	143x143 142x142	PSU PP	170°C 80°C



045O



143O

PORZELLAN & KUNSTSTOFFDECKEL

ARTIKELNUMMER	VE	Inhalt in ltr.	Gewicht in gr.	Höhe in mm	Stapelhöhe 11 St. in mm	Ø in mm	Material	Temp. bis
---------------	----	----------------	----------------	------------	-------------------------	---------	----------	-----------

BECHER | TASSEN | PORTIONSKANNEN

	V140 PR_Portionskanne 0,35 ltr.	2	0,35	375	81	845	101		
	passende Kunststoffdeckel:								
	026O Deckel FN_PORTKA_035_004 dunkelbraun	1		24	19	210	98	PP	83°C
	033O Deckel FK_PORTKA_035_004 grau	1		24	19	210	98	PP	83°C
	041O Deckel FL_PORTKA_035_004 flieder	1		24	19	210	98	PP	83°C
055O Deckel AA_PORTKA_035_004 grau-transparent	1		32	19	212	100	PSU	170°C	



026O



033O



041O





055O

	V142 PR_Becher mit Henkel 0,32 ltr.	6	0,35	325	96	1020	90		
	passender Kunststoffdeckel:								
	034O Deckel FK_Becher_002 grau	1		12	10	98	80	PP	83°C





034O

	V143 PR_Obertasse 0,18 ltr.	6	0,19	195	55	378	87		
---	------------------------------------	----------	-------------	------------	-----------	------------	-----------	--	--

	V144 PR_Untertasse 13,5 cm	6		185	22	113	137		
---	-----------------------------------	----------	--	------------	-----------	------------	------------	--	--

	V145 PR_Obertasse 0,18 ltr.	6	0,18	170	56	405	82		
---	------------------------------------	----------	-------------	------------	-----------	------------	-----------	--	--

	V146 PR_Untertasse 15 cm	6		170	20	87	147		
---	---------------------------------	----------	--	------------	-----------	-----------	------------	--	--

	V152 PR_Becher mit Henkel 0,25 ltr.	6	0,26	260	83	878	77		
	passender Kunststoffdeckel:								
	034O Deckel FK_Becher_002 grau	1		12	10	98	80	PP	83°C



034O

ARTIKELVERZEICHNIS

ARTIKELNUMMER	VE	Inhalt in ltr.	Gewicht in gr.	Höhe in mm	Stapelhöhe 11 St. in mm	Ø in mm	Material	Temp. bis
---------------	----	----------------	----------------	------------	-------------------------	---------	----------	-----------

BECHER | TASSEN | PORTIONSKANNEN

	V153 PR_Becher mit Henkel 0,30 ltr.	6	0,30	295	94	993	77		
	passende Kunststoffdeckel: 034O Deckel FK_Becher_002 grau	1		12	10	98	80	PP	83°C



	V177 PR_Untertasse 12,5 cm	6		145	19	100	126		
---	-----------------------------------	----------	--	------------	-----------	------------	------------	--	--

	V183 PR_Becher mit Henkel 0,28 ltr.	6	0,28	225	68	668	86		
---	--	----------	-------------	------------	-----------	------------	-----------	--	--

	V240 IM_Portionskanne 0,35 ltr.	2	0,35	390	83	790	101		
	passende Kunststoffdeckel:								
	026O Deckel FN_PORTKA_035_004 dunkelbraun	1		24	19	210	98	PP	83°C
	033O Deckel FK_PORTKA_035_004 grau	1		24	19	210	98	PP	83°C
	041O Deckel FL_PORTKA_035_004 flieder	1		24	19	210	98	PP	83°C
055O Deckel AA_PORTKA_035_004 grau-transparent	1		32	19	212	100	PSU	170°C	



	V511 PR_Portionskanne 0,27 ltr.	2	0,27	340	65	705	110		
	passende Kunststoffdeckel:								
	026O Deckel FN_PORTKA_035_004 dunkelbraun	1		24	19	210	98	PP	83°C
	033O Deckel FK_PORTKA_035_004 grau	1		24	19	210	98	PP	83°C
	041O Deckel FL_PORTKA_035_004 flieder	1		24	19	210	98	PP	83°C
	055O Deckel AA_PORTKA_035_004 grau-transparent	1		32	19	212	100	PSU	170°C
	175O Deckel HN_PORTKA_035_077 dunkelbraun	1		30	22	239	99	TPE-S	140°C
	177O Deckel HO_PORTKA_035_077 grün	1		30	22	239	99	TPE-S	140°C
	178O Deckel HK_PORTKA_035_077 grau	1		30	22	239	99	TPE-S	140°C



	V537 PR_Becher mit Henkel 0,28 ltr.	12	0,28	225	68	668	86		
---	--	-----------	-------------	------------	-----------	------------	-----------	--	--

	V540 PR_Untertasse 15 cm	6		250	17	118	152		
---	---------------------------------	----------	--	------------	-----------	------------	------------	--	--

PORZELLAN & KUNSTSTOFFDECKEL

ARTIKELNUMMER	VE	Inhalt in ltr.	Gewicht in gr.	Höhe in mm	Stapelhöhe 11 St. in mm	Ø in mm	Material	Temp. bis
---------------	----	----------------	----------------	------------	-------------------------	---------	----------	-----------

BECHER | TASSEN | PORTIONSKANNEN

	V577 PR_Becher mit Henkel 0,25 ltr.	6	0,27	255	80	814	79		
---	--	---	------	-----	----	-----	----	--	--

	V787 PR_Portionskanne 0,31 ltr.	2	0,34	325	70	670	110		
	passende Kunststoffdeckel:								
	026O Deckel FN_PORTKA_035_004 dunkelbraun	1		24	19	210	98	PP	83°C
	033O Deckel FK_PORTKA_035_004 grau	1		24	19	210	98	PP	83°C
	041O Deckel FL_PORTKA_035_004 flieder	1		24	19	210	98	PP	83°C
055O Deckel AA_PORTKA_035_004 grau-transparent	1		32	19	212	100	PSU	170°C	



026O



033O





041O





055O

SONSTIGES

	V136 PR_Setplatte 1 Spiegel	6		335	23	130	239x95		
---	------------------------------------	---	--	-----	----	-----	--------	--	--

	V137 PR_Setplatte 2 Spiegel	6		315	19	111	245x101		
---	------------------------------------	---	--	-----	----	-----	---------	--	--

	V178 PR_Eierbecher ohne Ablage	12	0,03	50	35	344	43		
---	---------------------------------------	----	------	----	----	-----	----	--	--

	V181 PR_Halbmondschale	2		425	22	160	218x149		
	passender Kunststoffdeckel: 102O Deckel KE_Halbmond_046 glasklar	1		107	33	144	226x160	PET	65°C



102O

	V199 PR_Eierbecher gross	12	0,04	80	40	418	50		
---	---------------------------------	----	------	----	----	-----	----	--	--

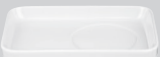
	V552 PR_Setplatte 16x11 cm	6		300	22	150	160x110		
---	-----------------------------------	---	--	-----	----	-----	---------	--	--

	V561 PR_Setplatte großer Spiegel	6		350	23	122	238x95		
---	---	---	--	-----	----	-----	--------	--	--

ARTIKELNUMMER	VE	Inhalt in ltr.	Gewicht in gr.	Höhe in mm	Stapelhöhe 11 St. in mm	Ø in mm	Material	Temp. bis
---------------	----	----------------	----------------	------------	-------------------------	---------	----------	-----------

PLANO SUPPENSCHALEN

	V301 PL_Suppenschale 0,40 ltr. mit Griff	6	0,40	285	65	247	120		
	passende Kunststoffdeckel:								
	021O Deckel FN_SUSCHA_040_006 dunkelbraun	1		45	13	146	126	PP	83°C
	028O Deckel FK_SUSCHA_040_006 grau	1		41	13	146	126	PP	83°C
	036O Deckel FL_SUSCHA_040_006 flieder	1		42	13	146	126	PP	83°C
	079O Deckel GR_SUSCHA_040_006 warm grey	1		62	13	144	126	PBT	170°C



021O



028O



036O



079O

	V339 PL_Suppenschale 0,31 ltr.	6	0,29	310	61	425	100		
	passende Kunststoffdeckel:								
	042O Deckel AA_SUSCHA_031_003 grau-transparent	1		22	14	150	100	PSU	170°C
	104O Deckel GR_SUSCHA_031_003 warm grey	1		22	14	150	100	PBT	170°C



042O



104O

	V351 PL_Suppenschale 0,31 ltr.	6	0,31	205	52	419	101		
	passende Kunststoffdeckel:								
	027O Deckel FK_SUSCHA_031_005 grau	1		27	12	126	105	PP	83°C
	084O Deckel HK_SUSCHA_031_037 grau	1		41	15	160	109	TPE-S	140°C
	181O Deckel GR_SUSCHA_031_005 warm grey	1		30	12	126	105	PBT	170°C



027O



084O



181O

	V367 PL_Suppenschale 0,26 ltr. mit Hkl.	6	0,26	185	53	305	99		
	passende Kunststoffdeckel:								
	042O Deckel AA_SUSCHA_031_003 grau-transparent	1		22	14	150	100	PSU	170°C
	104O Deckel GR_SUSCHA_031_003 warm grey	1		22	14	150	100	PBT	170°C



042O



104O

	V387 PL_Suppenschale 0,30 ltr. mit Hkl.	6	0,30	225	53	505	99		
	passende Kunststoffdeckel:								
	042O Deckel AA_SUSCHA_031_003 grau-transparent	1		22	14	150	100	PSU	170°C
	104O Deckel GR_SUSCHA_031_003 warm grey	1		22	14	150	100	PBT	170°C



042O



104O

	V397 PL_Suppenschale 0,30 ltr. mit 2 Hkl.	6	0,30	230	53	505	99		
	passende Kunststoffdeckel:								
	042O Deckel AA_SUSCHA_031_003 grau-transparent	1		22	14	150	100	PSU	170°C
	104O Deckel GR_SUSCHA_031_003 warm grey	1		22	14	150	100	PBT	170°C



042O



104O

PORZELLAN & KUNSTSTOFFDECKEL

ARTIKELNUMMER	VE	Inhalt in ltr.	Gewicht in gr.	Höhe in mm	Stapelhöhe 11 St. in mm	Ø in mm	Material	Temp. bis
---------------	----	----------------	----------------	------------	-------------------------	---------	----------	-----------

PLANO SUPPENSCHALEN

	V603 PL_Suppenschale 0,30 ltr. ohne Hkl.	6	0,30	210	53	511	99		
	passende Kunststoffdeckel:								
	042O Deckel AA_SUSCHA_031_003 grau-transparent	1		22	14	150	100	PSU	170°C
	104O Deckel GR_SUSCHA_031_003 warm grey	1		22	14	150	100	PBT	170°C



042O

104O

	V611 PL_Suppenschale 0,40 ltr.	4	0,45	280	40	290	137		
	passende Kunststoffdeckel:								
	046O Deckel AA_SUSCHA_RD_009 grau-transparent	1		44	15	155	140	PSU	170°C
	086O Deckel HK_SUSCHA_050_039 grau	1		68	15	170	140	TPE-S	140°C
	142O Deckel FY_SUSCHA_RD_009 grau-transparent	1		32	14	155	139	PP	80°C



046O

086O

142O

	V620 PL_Suppenschale	6	0,32	180	59	252	103		
	passende Kunststoffdeckel:								
	027O Deckel FK_SUSCHA_031_005 grau	1		27	12	126	105	PP	83°C
	084O Deckel HK_SUSCHA_031_037 grau	1		41	15	160	109	TPE-S	140°C
	181O Deckel GR_SUSCHA_031_005 warm grey	1		30	12	126	105	PBT	170°C



027O

084O

181O

	V631 PL_Suppenschale schwappsicher 0,45 ltr.	6	0,50	315	62	412	122		
	passende Kunststoffdeckel:								
	021O Deckel FN_SUSCHA_040_006 dunkelbraun	1		45	13	146	126	PP	83°C
	028O Deckel FK_SUSCHA_040_006 grau	1		41	13	146	126	PP	83°C
	036O Deckel FL_SUSCHA_040_006 flieder	1		42	13	146	126	PP	83°C
	079O Deckel GR_SUSCHA_040_006 warm grey	1		62	13	144	126	PBT	170°C
149O Deckel AA_SUSCHASCHW_068 grau-transparent	1		35	11	111	125	PSU	170°C	



021O

028O

036O

079O

149O

	V648 PL_Suppenschale 0,31 ltr.	6	0,31	220	51	520	101		
	passende Kunststoffdeckel:								
	027O Deckel FK_SUSCHA_031_005 grau	1		27	12	126	105	PP	83°C
	084O Deckel HK_SUSCHA_031_037 grau	1		41	15	160	109	TPE-S	140°C
	181O Deckel GR_SUSCHA_031_005 warm grey	1		30	12	126	105	PBT	170°C



027O

084O

181O

ARTIKELNUMMER	VE	Inhalt in ltr.	Gewicht in gr.	Höhe in mm	Stapelhöhe 11 St. in mm	Ø in mm	Material	Temp. bis
---------------	----	----------------	----------------	------------	-------------------------	---------	----------	-----------

PLANO EINTOPFSCHALEN



V312 PL_Eintopfschale 1,10 ltr.	4	1,25	520	59	285	194		
passende Kunststoffdeckel:								
024O Deckel FN_EINTOPF1,1_012 dunkelbraun	1		114	15	155	201	PP	83°C
031O Deckel FK_EINTOPF1,1_012 grau	1		112	15	155	201	PP	83°C
039O Deckel FL_EINTOPF1,1_012 flieder	1		115	15	155	201	PP	83°C
054O Deckel AA_EINTOPF1,1_011 grau-transparent	1		97	12	132	200	PSU	170°C
081O Deckel GR_EINTOPF1,1_012 warm grey	1		164	14	157	201	PBT	170°C
155O Deckel FY_EINTOPF1,1_011 grau-transparent	1		100	12	132	200	PP	80°C



V365 PL_Eintopfeller 23 cm	6	1,15	560	39	261	225		
passende Kunststoffdeckel:								
057O Deckel AA_TELLER_230_015 grau-transparent	1		148	41	161	238	PSU	170°C
083O Deckel GR_TELLER_230_015 warm grey	1		156	40	160	235	PBT	170°C
122O Deckel FV_TELLER_230_045 glasklar-milchig	1		86	40	150	239	PP	88°C
151O Deckel FY_TELLER_230_015 grau-transparent	1		150	41	161	238	PP	80°C

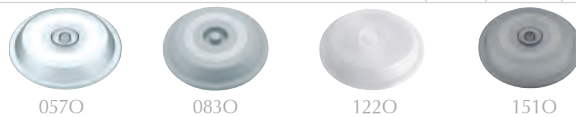

V609 PL_Eintopfschale 0,50 ltr.	6	0,68	430	62	590	135		
passende Kunststoffdeckel:								
007O Deckel AA_SUSCHA_050_007 grau-transparent	1		53	13	134	140	PSU	170°C
022O Deckel FN_SUSCHA_050_008 dunkelbraun	1		60	14	152	137	PP	83°C
029O Deckel FK_SUSCHA_050_008 grau	1		58	14	152	139	PP	83°C
037O Deckel FL_SUSCHA_050_008 flieder	1		58	14	152	139	PP	83°C
080O Deckel GR_SUSCHA_050_008 warm grey	1		81	14	153	139	PBT	170°C
086O Deckel HK_SUSCHA_050_039 grau	1		68	15	170	140	TPE-S	140°C
113O Deckel FV_SUSCHA_050_007 glasklar-milchig	1		32	13	128	139	PP	88°C
142O Deckel FY_SUSCHA_RD_009 grau-transparent	1		32	14	155	139	PP	80°C
156O Deckel FY_SUSCHA_050_007 grau-transparent	1		45	13	134	140	PP	80°C



V610 PL_Eintopfschale 0,40 ltr.	6	0,52	355	50	468	135		
passende Kunststoffdeckel:								
007O Deckel AA_SUSCHA_050_007 grau-transparent	1		53	13	134	140	PSU	170°C
022O Deckel FN_SUSCHA_050_008 dunkelbraun	1		60	14	152	137	PP	83°C
029O Deckel FK_SUSCHA_050_008 grau	1		58	14	152	139	PP	83°C
037O Deckel FL_SUSCHA_050_008 flieder	1		58	14	152	139	PP	83°C
080O Deckel GR_SUSCHA_050_008 warm grey	1		81	14	153	139	PBT	170°C
086O Deckel HK_SUSCHA_050_039 grau	1		68	15	170	140	TPE-S	140°C
113O Deckel FV_SUSCHA_050_007 glasklar-milchig	1		32	13	128	139	PP	88°C
156O Deckel FY_SUSCHA_050_007 grau-transparent	1		45	13	134	140	PP	80°C

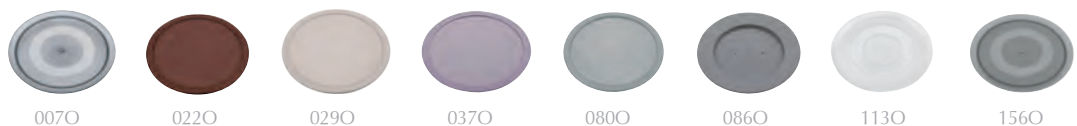

PORZELLAN & KUNSTSTOFFDECKEL

ARTIKELNUMMER	VE	Inhalt in ltr.	Gewicht in gr.	Höhe in mm	Stapelhöhe 11 St. in mm	Ø in mm	Material	Temp. bis
---------------	----	----------------	----------------	------------	-------------------------	---------	----------	-----------

PLANO EINTOPFSCHALEN

	V635 PL_Eintopfschale schwappsicher 21 cm	4	1,50	685	56	346	210		
	passende Kunststoffdeckel:								
	025O Deckel FN_EINTOPF1,2_013 dunkelbraun	1		124	13	147	218	PP	83°C
	032O Deckel FK_EINTOPF1,2_013 grau	1		125	13	147	218	PP	83°C
	040O Deckel FL_EINTOPF1,2_013 flieder	1		128	13	147	218	PP	83°C
	132O Deckel GR_EINTOPF1,2_013 warm grey	1		178	40	160	262	PBT	170°C



	V646 PL_Eintopfschale schwappsicher 17,5 ltr.	2	1,00	540	53	511	171		
	passende Kunststoffdeckel:								
	023O Deckel FN_SUSCHA_090_010 dunkelbraun	1		77	12	121	180	PP	83°C
	030O Deckel FK_SUSCHA_090_010 grau	1		79	12	121	180	PP	83°C
	038O Deckel FL_SUSCHA_090_010 flieder	1		79	12	121	180	PP	83°C
	148O Deckel GR_Eintopf1,0_010 warm grey	1		110	12	122	178	PBT	170°C



	V765 PL_Eintopfeller 23 cm	6	1,15	560	39	259	227		
	passende Kunststoffdeckel:								
	057O Deckel AA_TELLER_230_015 grau-transparent	1		148	41	161	238	PSU	170°C
	083O Deckel GR_TELLER_230_015 warm grey	1		156	40	160	235	PBT	170°C
	122O Deckel FV_TELLER_230_045 glasklar-milchig	1		86	40	150	239	PP	88°C
	151O Deckel FY_TELLER_230_015 grau-transparent	1		150	41	161	238	PP	80°C



PLANO TELLER

	V315 PL_Teller flach 25,5 cm	6		650	21	97	256		
	passende Kunststoffdeckel:								
	056O Deckel AA_TELLER_255_016 grau-transparent	1		186	41	174	265	PSU	170°C
	087O Deckel IK_TELLER_255_040 grau	1		230	41	174	269	PBT	160°C
	089O Deckel EE_TELLER_255_040 glasklar	1		207	41	175	270	PC	110°C
	112O Deckel FV_TELLER_255_049 glasklar-milchig	1		134	40	164	264	PP	88°C
	131O Deckel GR_TELLER_255_019 warm grey	1		190	40	160	262	PBT	170°C
	145O Deckel FY_TELLER_255_016 grau-transparent	1		134	40	164	263	PP	80°C
	160O Deckel GR_TE_HOCH_255_016 warm grey	1		205	51	231	268	PBT	170°C
	167O Deckel MA_TELLER_255_016 grau-transparent	1		165	41	160	265	PA	140°C



ARTIKELVERZEICHNIS

ARTIKELNUMMER	VE	Inhalt in ltr.	Gewicht in gr.	Höhe in mm	Stapelhöhe 11 St. in mm	Ø in mm	Material	Temp. bis
---------------	----	----------------	----------------	------------	-------------------------	---------	----------	-----------

PLANO TELLER

	V316 PL_Teller halbtief 25,5 cm	6		690	26	117	256		
	passende Kunststoffdeckel:								
	056O Deckel AA_TELLER_255_016 grau-transparent	1		186	41	174	265	PSU	170°C
	087O Deckel IK_TELLER_255_040 grau	1		230	41	174	269	PBT	160°C
	089O Deckel EE_TELLER_255_040 glasklar	1		207	41	175	270	PC	110°C
	112O Deckel FV_TELLER_255_049 glasklar-milchig	1		134	40	164	264	PP	88°C
	131O Deckel GR_TELLER_255_019 warm grey	1		190	40	160	262	PBT	170°C
	145O Deckel FY_TELLER_255_016 grau-transparent	1		134	40	164	263	PP	80°C
	160O Deckel GR_TE_HOCH_255_016 warm grey	1		205	51	231	268	PBT	170°C
	167O Deckel MA_TELLER_255_016 grau-transparent	1		165	41	160	265	PA	140°C



	V317 PL_Teller flach 24,5 cm Coup	6	0,55	670	24	121	243		
--	--	----------	-------------	------------	-----------	------------	------------	--	--

	V350 PL_Teller flach 23 cm	6		550	22	156	230		
	passende Kunststoffdeckel:								
	057O Deckel AA_TELLER_230_015 grau-transparent	1		148	41	161	238	PSU	170°C
	083O Deckel GR_TELLER_230_015 warm grey	1		156	40	160	235	PBT	170°C
	100O Deckel IK_TELLER_230_045 grau	1		193	40	180	239	PBT	160°C
	122O Deckel FV_TELLER_230_045 glasklar-milchig	1		86	40	150	239	PP	88°C
	130O Deckel AA_TE_HOCH_230_061 grau-transparent	1		156	51	190	237	PSU	170°C
	147O Deckel GR_TE_HOCH_230_067 warm grey	1		156	51	161	236	PBT	170°C
	151O Deckel FY_TELLER_230_015 grau-transparent	1		150	41	161	238	PP	80°C
	171O Deckel MA_TELLER_230_015 grau-transparent	1		115	40	170	241	PA	140°C



	V366 PL_Teller tief 23 cm	6	0,80	600	29	226	227		
	passende Kunststoffdeckel:								
	057O Deckel AA_TELLER_230_015 grau-transparent	1		148	41	161	238	PSU	170°C
	083O Deckel GR_TELLER_230_015 warm grey	1		156	40	160	235	PBT	170°C
	100O Deckel IK_TELLER_230_045 grau	1		193	40	180	239	PBT	160°C
	122O Deckel FV_TELLER_230_045 glasklar-milchig	1		86	40	150	239	PP	88°C
	130O Deckel AA_TE_HOCH_230_061 grau-transparent	1		156	51	190	237	PSU	170°C
	147O Deckel GR_TE_HOCH_230_067 warm grey	1		156	51	161	236	PBT	170°C
	151O Deckel FY_TELLER_230_015 grau-transparent	1		150	41	161	238	PP	80°C
	171O Deckel MA_TELLER_230_015 grau-transparent	1		115	40	170	241	PA	140°C



	V369 PL_Teller tief 19,5 cm Coup	6	0,50	430	27	173	197		
	passender Kunststoffdeckel:								
	125O Deckel FV_TELLER_200_014 glasklar-milchig	1		106	55	155	211	PP	88°C



PORZELLAN & KUNSTSTOFFDECKEL

ARTIKELNUMMER	VE	Inhalt in ltr.	Gewicht in gr.	Höhe in mm	Stapelhöhe 11 St. in mm	Ø in mm	Material	Temp. bis
---------------	----	----------------	----------------	------------	-------------------------	---------	----------	-----------

PLANO TELLER

	V633 PL_Teller 4-eckig 24 cm	6	525	22	106	212x212		
	passende Kunststoffdeckel:							
	044O Deckel AA_TELLER_4EC_025 grau-transparent	1	151	41	170	223x223	PSU	170°C
	109O Deckel DD_TELLER_4EC_025 transparent	1	141	42	170	223x223	PC	100°C
	163O Deckel GR_TELLER_4EC_025 warm grey	1	150	40	170	220x220	PBT	170°C



	V647 PL_Teller rund 23 cm	6	520	23	90	230		
	passende Kunststoffdeckel:							
	057O Deckel AA_TELLER_230_015 grau-transparent	1	148	41	161	238	PSU	170°C
	083O Deckel GR_TELLER_230_015 warm grey	1	156	40	160	235	PBT	170°C
	100O Deckel IK_TELLER_230_045 grau	1	193	40	180	238	PBT	160°C
	122O Deckel FV_TELLER_230_045 glasklar-milchig	1	86	40	150	239	PP	88°C
	130O Deckel AA_TE_HOCH_230_061 grau-transparent	1	156	51	190	237	PSU	170°C
	151O Deckel FY_TELLER_230_015 grau-transparent	1	150	41	161	238	PP	80°C
	171O Deckel MA_TELLER_230_015 grau-transparent	1	115	40	170	241	PA	140°C





PLANO PLATTEN

	V319 PL_Platte rund 3-tlg. 25,5 cm	2	900	27	148	253		
	passende Kunststoffdeckel:							
	056O Deckel AA_TELLER_255_016 grau-transparent	1	186	41	174	265	PSU	170°C
	112O Deckel FV_TELLER_255_049 glasklar-milchig	1	134	40	164	264	PP	88°C
	131O Deckel GR_TELLER_255_019 warm grey	1	190	40	160	262	PBT	170°C
	145O Deckel FY_TELLER_255_016 grau-transparent	1	134	40	164	263	PP	80°C
	160O Deckel GR_TE_HOCH_255_016 warm grey	1	205	51	231	268	PBT	170°C
167O Deckel MA_TELLER_255_016 grau-transparent	1	165	41	160	265	PA	140°C	

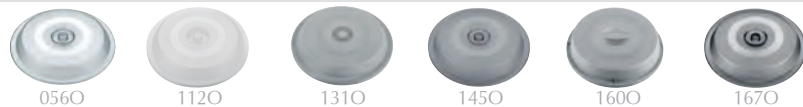

	V320 PL_Platte rund 3-tlg. 25,5 cm Coup	2	770	27	133	255		
	passende Kunststoffdeckel:							
	056O Deckel AA_TELLER_255_016 grau-transparent	1	186	41	174	265	PSU	170°C
	112O Deckel FV_TELLER_255_049 glasklar-milchig	1	134	40	164	264	PP	88°C
	131O Deckel GR_TELLER_255_019 warm grey	1	190	40	160	262	PBT	170°C
	145O Deckel FY_TELLER_255_016 grau-transparent	1	134	40	164	263	PP	80°C
	160O Deckel GR_TE_HOCH_255_016 warm grey	1	205	51	231	268	PBT	170°C
	167O Deckel MA_TELLER_255_016 grau-transparent	1	165	41	160	265	PA	140°C



	V321 PL_Platte rund 3-tlg. 24,5 cm Coup	2	805	26	143	242		

ARTIKELNUMMER	VE	Inhalt in ltr.	Gewicht in gr.	Höhe in mm	Stapelhöhe 11 St. in mm	Ø in mm	Material	Temp. bis
---------------	----	----------------	----------------	------------	-------------------------	---------	----------	-----------

PLANO PLATTEN

	V325 PL-Platte eckig 1-tlg. 20x20 cm	2		575	23	154	201x201		
	passender Kunststoffdeckel: 0490 Deckel AA_PLATTE2020_023 grau-transparent	1		158	46	170	209x209	PSU	170°C



0490

	V347 PL-Teller rund 2-tlg. 23 cm	6		625	22	183	231		
	passende Kunststoffdeckel: 0570 Deckel AA_TELLER_230_015 grau-transparent 0830 Deckel GR_TELLER_230_015 warm grey 1000 Deckel IK_TELLER_230_045 grau 1220 Deckel FV_TELLER_230_045 glasklar-milchig 1300 Deckel AA_TE_HOCH_230_061 grau-transparent 1510 Deckel FY_TELLER_230_015 grau-transparent 1710 Deckel MA_TELLER_230_015 grau-transparent	1 1 1 1 1 1 1		148 156 193 86 156 150 115	41 40 40 40 51 41 40	161 160 180 150 190 161 170	238 235 239 239 237 238 241	PSU PBT PBT PP PSU PP PA	170°C 170°C 160°C 88°C 170°C 80°C 140°C



0570



0830



1000



1220



1300



1510



1710

	V356 PL-Platte rund 2-tlg. 25,5 cm Coup	2		760	24	135	253		
	passende Kunststoffdeckel: 0560 Deckel AA_TELLER_255_016 grau-transparent 1120 Deckel FV_TELLER_255_049 glasklar-milchig 1310 Deckel GR_TELLER_255_019 warm grey 1450 Deckel FY_TELLER_255_016 grau-transparent 1600 Deckel GR_TE_HOCH_255_016 warm grey 1670 Deckel MA_TELLER_255_016 grau-transparent	1 1 1 1 1 1		186 134 190 134 205 165	41 40 40 40 51 41	174 164 160 164 231 160	265 264 262 263 268 265	PSU PP PBT PP PBT PA	170°C 88°C 170°C 80°C 170°C 140°C



0560



1120



1310



1450



1600



1670

	V357 PL-Schale eckig 1-tlg. 24,5x19 cm	6	1,05	750	42	188	240x194		
---	---	----------	-------------	------------	-----------	------------	----------------	--	--

	V358 PL-Schale eckig 2-tlg. 24,5x19 cm	6	0,60	735	28	230	242x191		
---	---	----------	-------------	------------	-----------	------------	----------------	--	--

	V386 PL-Teller rund 3-tlg. 23 cm	6		605	21	178	230		
	passende Kunststoffdeckel: 0570 Deckel AA_TELLER_230_015 grau-transparent 0830 Deckel GR_TELLER_230_015 warm grey 1000 Deckel IK_TELLER_230_045 grau 1220 Deckel FV_TELLER_230_045 glasklar-milchig 1300 Deckel AA_TE_HOCH_230_061 grau-transparent 1470 Deckel GR_TE_HOCH_230_067 warm grey 1510 Deckel FY_TELLER_230_015 grau-transparent 1710 Deckel MA_TELLER_230_015 grau-transparent	1 1 1 1 1 1 1 1		148 156 193 86 156 156 150 115	41 40 40 40 51 51 41 40	161 160 180 150 190 161 161 170	238 235 239 239 237 236 238 241	PSU PBT PBT PP PSU PBT PP PA	170°C 170°C 160°C 88°C 170°C 170°C 80°C 140°C



0570



0830



1000



1220



1300



1470



1510



1710

PORZELLAN & KUNSTSTOFFDECKEL

ARTIKELNUMMER	VE	Inhalt in ltr.	Gewicht in gr.	Höhe in mm	Stapelhöhe 11 St. in mm	Ø in mm	Material	Temp. bis
---------------	----	----------------	----------------	------------	-------------------------	---------	----------	-----------

PLANO PLATTEN

	V389 PL_Teller rund 2-tlg. 23 cm	6	0,45	700	22	185	231		
	passende Kunststoffdeckel:								
	057O Deckel AA_TELLER_230_015 grau-transparent	1		148	41	161	238	PSU	170°C
	083O Deckel GR_TELLER_230_015 warm grey	1		156	40	160	235	PBT	170°C
	122O Deckel FV_TELLER_230_045 glasklar-milchig	1		86	40	150	239	PP	88°C
	130O Deckel AA_TE_HOCH_230_061 grau-transparent	1		156	51	190	237	PSU	170°C
	147O Deckel GR_TE_HOCH_230_067 warm grey	1		156	51	161	236	PBT	170°C
	151O Deckel FY_TELLER_230_015 grau-transparent	1		150	41	161	238	PP	80°C
171O Deckel MA_TELLER_230_015 grau-transparent	1		115	40	170	241	PA	140°C	



057O



083O



122O



130O



147O



151O



171O



V502 PL_Platte eckig 1-tlg. 27x17 cm	6		740	31	154	278x175		
passender Kunststoffdeckel:								
076O Deckel GR_PLATTE2717_033 warm grey	1		240	37	220	285x181	PBT	170°C



076O



V503 PL_Platte eckig 2-tlg. 27x17 cm	6		795	31	163	277x173		
passender Kunststoffdeckel:								
076O Deckel GR_PLATTE2717_033 warm grey	1		240	37	220	285x181	PBT	170°C



076O



V608 PL_Platte rund 13 cm	1		165	14	120	137		
----------------------------------	----------	--	------------	-----------	------------	------------	--	--



V634 PL_Teller 4-eckig 2-tlg. 24 cm	6		545	23	108	212x212		
passende Kunststoffdeckel:								
044O Deckel AA_TELLER_4EC_025 grau-transparent	1		151	41	170	223x223	PSU	170°C
109O Deckel DD_TELLER_4EC_025 transparent	1		141	42	170	223x223	PC	100°C
163O Deckel GR_TELLER_4EC_025 warm grey	1		150	40	170	220x220	PBT	170°C



044O



109O



163O

ARTIKELVERZEICHNIS

ARTIKELNUMMER	VE	Inhalt in ltr.	Gewicht in gr.	Höhe in mm	Stapelhöhe 11 St. in mm	Ø in mm	Material	Temp. bis
---------------	----	----------------	----------------	------------	-------------------------	---------	----------	-----------

PLANO SALAT- und BEILAGENSCHALEN

	V308 PL_Salatschale rund 12 cm	4	0,40	255	51	372	120		
	passende Kunststoffdeckel:								
	021O Deckel FN_SUSCHA_040_006 dunkelbraun	1		45	13	146	126	PP	83°C
	028O Deckel FK_SUSCHA_040_006 grau	1		41	13	146	126	PP	83°C
	036O Deckel FL_SUSCHA_040_006 flieder	1		42	13	146	126	PP	83°C
	079O Deckel GR_SUSCHA_040_006 warm grey	1		62	13	144	126	PBT	170°C



021O



028O



036O



079O

	V330 PL_Schale eckig 11x8,5 cm	6	0,16	200	34	196	111x84		
	passender Kunststoffdeckel:								
	105O Deckel KE_SCHALE1185_047 glasklar	1		50	33	165	121x89	PET	65°C



105O

	V334 PL_Salatschale eckig 10x10 cm	12	0,25	210	46	249	101x101		
	passender Kunststoffdeckel:								
	058O Deckel AA_SALAT_EC12_019 grau-transparent	1		30	27	140	105x105	PSU	170°C
	169O Deckel FY_SALAT_EC12_019 grau-transparent	1		22	27	137	106x106	PP	80°C



058O

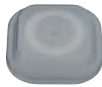

169O

	V392 PL_Salatschale eckig 20x10 cm	6	0,58	410	48	260	201x103		
	passender Kunststoffdeckel:								
	063O Deckel AA_SALAT_2010_032 grau-transparent	1		77	27	142	205x106	PSU	170°C



063O

	V621 PL_Schale hoch 11x8,5 cm	6	0,30	235	47	350	113x84		
	passende Kunststoffdeckel:								
	121O Deckel FK_SCHALE_HOCH_057 grau	1		24	19	209	117x87	PP	110°C
	129O FV_SCHALE_HOCH_057 glasklar-milchig	1		25	19	190	117x87	PP	88°C



121O













129O

	V622 PL_Schale hoch 17,5x11 cm	5	0,60	405	48	220	175x114		
	passender Kunststoffdeckel:								
	106O Deckel KE_SCHALE1117_048 glasklar	1		85	33	165	182x120	PET	65°C



106O

PORZELLAN & KUNSTSTOFFDECKEL

ARTIKELNUMMER	VE	Inhalt in ltr.	Gewicht in gr.	Höhe in mm	Stapelhöhe 11 St. in mm	Ø in mm	Material	Temp. bis
PLANO SONSTIGES								
	V348 PL_GN-Schale 1157 1/3	1	1,90	1035	56	261	311x170	
	V354 PL_GN-Schale 1/6	1	0,80	530	56	258	164x152	
	V368 PL_Sauciere 0,10 ltr.	12	0,09	95	43	350	68	
	passende Kunststoffdeckel:							
	061O Deckel AA_SAUCIERE_001 grau-transparent	1		12	11	122	68	PSU 170°C
	146O Deckel FY_SAUCIERE_001 grau-transparent	1		8	11	122	68	PP 80°C
		061O						
		146O						
	V375 PL_GN-Schale niedrig 1/9	2	0,50	355	57	279	164x94	
	V380 PL_Sauciere 0,09 ltr. mit Henkel	4	0,09	135	44	436	68	
	passende Kunststoffdeckel:							
	061O Deckel AA_SAUCIERE_001 grau-transparent	1		12	11	122	68	PSU 170°C
	146O Deckel FY_SAUCIERE_001 grau-transparent	1		8	11	122	68	PP 80°C
		061O						
		146O						
	V637 PL_GN-Schale 1/2 55 mm	1	3,20	2030	55	485	322x260	

ARTIKELVERZEICHNIS

ARTIKELNUMMER	VE	Inhalt in ltr.	Gewicht in gr.	Höhe in mm	Stapelhöhe 11 St. in mm	Ø in mm	Material	Temp. bis
---------------	----	----------------	----------------	------------	-------------------------	---------	----------	-----------

ELFENBEIN

	V215 IM_Teller flach 25,5 cm	6		730	26	133	255		
	passende Kunststoffdeckel:								
	056O Deckel AA_TELLER_255_016 grau-transparent	1		186	41	174	265	PSU	170°C
	087O Deckel IK_TELLER_255_040 grau	1		230	41	174	269	PBT	160°C
	089O Deckel EE_TELLER_255_040 glasklar	1		207	41	175	270	PC	110°C
	112O Deckel FV_TELLER_255_049 glasklar-milchig	1		134	40	164	264	PP	88°C
	131O Deckel GR_TELLER_255_019 warm grey	1		190	40	160	262	PBT	170°C
	145O Deckel FY_TELLER_255_016 grau-transparent	1		134	40	164	263	PP	80°C
	160O Deckel GR_TE_HOCH_255_016 warm grey	1		205	51	231	268	PBT	170°C
	167O Deckel MA_TELLER_255_016 grau-transparent	1		165	41	160	265	PA	140°C



	V232 IM_Salatschale eckig 12x12 cm	4	0,31	310	43	276	117x117		
	passende Kunststoffdeckel:								
	051O Deckel EE_SALAT_HOCH_021 glasklar	1		68	31	131	124x124	PC	110°C
	060O Deckel EE_SALAT_EC_G_018 glasklar	1		60	16	180	118x118	PC	110°C
	064O Deckel AA_SALAT_EC15_020 grau-transparent	1		56	27	142	123x123	PSU	170°C



	V312 PL_Eintopfschale 1,10 ltr.	4	1,25	520	59	285	194		
	passende Kunststoffdeckel:								
	024O Deckel FN_EINTOPF1,1_012 dunkelbraun	1		114	15	155	201	PP	83°C
	031O Deckel FK_EINTOPF1,1_012 grau	1		112	15	155	201	PP	83°C
	039O Deckel FL_EINTOPF1,1_012 flieder	1		115	15	155	201	PP	83°C
	054O Deckel AA_EINTOPF1,1_011 grau-transparent	1		97	12	132	200	PSU	170°C
	081O Deckel GR_EINTOPF1,1_012 warm grey	1		164	14	157	201	PBT	170°C
	155O Deckel FY_EINTOPF1,1_011 grau-transparent	1		100	12	132	200	PP	80°C



	V325 PL_Platte eckig 1-tlg. 20x20 cm	2		615	23	154	201x201		
	passender Kunststoffdeckel:								
	049O Deckel AA_PLATTE2020_023 grau-transparent	1		158	46	170	209x209	PSU	170°C



	V334 PL_Salatschale eckig 10x10 cm	12	0,25	210	46	249	101x101		
	passende Kunststoffdeckel:								
	058O Deckel AA_SALAT_EC12_019 grau-transparent	1		30	27	140	105x105	PSU	170°C
	169O Deckel FY_Salat_EC12_019 grau-transparent	1		22	27	137	106x106	PP	80°C

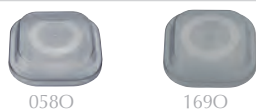







PORZELLAN & KUNSTSTOFFDECKEL

ARTIKELNUMMER	VE	Inhalt in ltr.	Gewicht in gr.	Höhe in mm	Stapelhöhe 11 St. in mm	Ø in mm	Material	Temp. bis
ELFENBEIN								
	V348 PL_GN-Schale 1157 1/3	1	1,90	1035	56	261	311x170	
	V350 PL_Teller flach 23 cm passende Kunststoffdeckel: 0570 Deckel AA_TELLER_230_015 grau-transparent 0830 Deckel GR_TELLER_230_015 warm grey 1000 Deckel IK_TELLER_230_045 grau 1220 Deckel FV_TELLER_230_045 glasklar-milchig 1300 Deckel AA_TE_HOCH_230_061 grau-transparent 1470 Deckel GR_TE_HOCH_230_067 warm grey 1510 Deckel FY_TELLER_230_015 grau-transparent 1710 Deckel MA_TELLER_230_015 grau-transparent	6		550	22	156	230	
		1		148	41	161	238	PSU 170°C
		1		156	40	160	235	PBT 170°C
		1		193	40	180	239	PBT 160°C
		1		86	40	150	239	PP 88°C
		1		156	51	190	237	PSU 170°C
		1		156	51	161	236	PBT 170°C
		1		150	41	161	238	PP 80°C
		1		115	40	170	241	PA 140°C
								
								
								
								
								
								
								
								
	V354 PL_GN-Schale 1/6	1	0,80	530	56	258	164x152	
	V367 PL_Suppenschale 0,26 ltr. mit Hkl. passende Kunststoffdeckel: 0420 Deckel AA_SUSCHA_031_003 grau-transparent 1040 Deckel GR_SUSCHA_031_003 warm grey	6	0,26	185	53	305	99	
		1		22	14	150	100	PSU 170°C
		1		22	14	150	100	PBT 170°C
								
								
	V368 PL_Sauciere 0,10 ltr. passende Kunststoffdeckel: 0610 Deckel AA_SAUCIERE_001 grau-transparent 1460 Deckel FY_SAUCIERE_001 grau-transparent	12	0,09	95	43	350	68	
		1		12	11	122	68	PSU 170°C
		1		8	11	122	68	PP 80°C
								
								
	V375 PL_GN-Schale niedrig 1/9	2	0,50	355	57	279	164x94	







ARTIKELVERZEICHNIS

ARTIKELNUMMER		VE	Inhalt in ltr.	Gewicht in gr.	Höhe in mm	Stapelhöhe 11 St. in mm	Ø in mm	Material	Temp. bis
ELFENBEIN									
	V380 PL_Sauciere 0,09 ltr. mit Hkl.	4	0,09	135	44	436	68		
	passende Kunststoffdeckel:								
	061O Deckel AA_SAUCIERE_001 grau-transparent	1		12	11	122	68	PSU	170°C
	146O Deckel FY_SAUCIERE_001 grau-transparent	1		8	11	122	68	PP	80°C
	 								
	061O 146O								
	V387 PL_Suppenschale 0,30 ltr. mit Hkl.	6	0,30	225	53	505	99		
	passende Kunststoffdeckel:								
	042O Deckel AA_SUSCHA_031_003 grau-transparent	1		22	14	150	100	PSU	170°C
	104O Deckel GR_SUSCHA_031_003 warm grey	1		22	14	150	100	PBT	170°C
	 								
	042O 104O								
	V389 PL_Teller rund 2-tlg. 23 cm	6		700	22	185	231		
	passende Kunststoffdeckel:								
	057O Deckel AA_TELLER_230_015 grau-transparent	1		148	41	161	238	PSU	170°C
	083O Deckel GR_TELLER_230_015 warm grey	1		156	40	160	235	PBT	170°C
	100O Deckel IK_TELLER_230_045 grau	1		193	40	180	239	PBT	160°C
	122O Deckel FV_TELLER_230_045 glasklar-milchig	1		86	40	150	239	PP	88°C
	130O Deckel AA_TE_HOCH_230_061 grau-transparent	1		156	51	190	237	PSU	170°C
	147O Deckel GR_TE_HOCH_230_067 warm grey	1		156	51	161	236	PBT	170°C
	151O Deckel FY_TELLER_230_015 grau-transparent	1		150	41	161	238	PP	80°C
	171O Deckel MA_TELLER_230_015 grau-transparent	1		115	40	170	241	PA	140°C
		       							
	057O 083O 100O 122O 130O 147O 151O 171O								
	V392 PL_Salatschale eckig 20x10 cm	6	0,58	410	48	260	201x103		
	passender Kunststoffdeckel:								
	063O Deckel AA_SALAT_2010_032 grau-transparent	1		77	27	142	205x106	PSU	170°C
									
	063O								
	V397 PL_Suppenschale 0,30 ltr. mit 2 Hkl.	6	0,30	230	53	505	99		
	passende Kunststoffdeckel:								
	042O Deckel AA_SUSCHA_031_003 grau-transparent	1		22	14	150	100	PSU	170°C
	104O Deckel GR_SUSCHA_031_003 warm grey	1		22	14	150	100	PBT	170°C
	 								
	042O 104O								
	V535 PR_Dressingschälchen 0,08 ltr.	12	0,07	85	42	430	59		







KUNSTSTOFFDECKEL

ARTIKELNUMMER	VE	Material	Temperatur bis	
	<p>0070 Deckel AA_SUSCHA_050_007 grau-transparent</p> <p>passend für: V103 PR_Suppenschale 0,50 ltr. mit Griff V106 MA_Salatschale rund 13 cm V202 IM_Suppenschale 0,45 ltr. mit Griff V203 IM_Suppenschale 0,50 ltr. mit Griff V206 IM_Salatschale rund 13 cm V609 PL_Eintopfschale 0,50 ltr. V610 PL_Eintopfschale 0,40 ltr.</p>	1	PSU	170°C
	<p>0210 Deckel FN_SUSCHA_040_006 dunkelbraun</p> <p>passend für: V101 PR_Suppenschale_0,40 ltr. mit Griff V108 PR_Salatschale rund 12 cm V161 PR_Suppenschale 0,40 ltr. V190 PR_Salatschale rund 12 cm V201 IM_Suppenschale 0,40 ltr. mit Griff V301 PL_Suppenschale 0,40 ltr. mit Griff V308 PL_Salatschale rund 12 cm V531 PR_Suppenschale schwappsicher 0,45 ltr. V631 PL_Suppenschale schwappsicher 0,45 ltr.</p>	1	PP	83°C
	<p>0220 Deckel FN_SUSCHA_050_008 dunkelbraun</p> <p>passend für: V103 PR_Suppenschale 0,50 ltr. mit Griff V106 MA_Salatschale rund 13 cm V202 IM_Suppenschale 0,45 ltr. mit Griff V203 IM_Suppenschale 0,50 ltr. mit Griff V206 IM_Salatschale rund 13 cm V609 PL_Eintopfschale 0,50 ltr. V610 PL_Eintopfschale 0,40 ltr.</p>	1	PP	83°C
	<p>0230 Deckel FN_SUSCHA_090_010 dunkelbraun</p> <p>passend für: V104 PR_Suppenschale 0,90 ltr. mit Griff V110 PR_Eintopfschale 0,95 ltr. V204 IM_Suppenschale 0,90 ltr. mit Griff V210 IM_Eintopfschale 0,90 ltr. V646 PL_Eintopfschale schwappsicher 17,5 cm</p>	1	PP	83°C
	<p>0240 Deckel FN_EINTOPF1,1_012 dunkelbraun</p> <p>passend für: V112 PR_Eintopfschale 1,10 ltr. V212 IM_Eintopfschale 1,10 ltr. V312 PL_Eintopfschale 1,10 ltr. V591 PR_Eintopf 1,00 ltr.</p>	1	PP	83°C
	<p>0250 Deckel FN_EINTOPF1,2_013 dunkelbraun</p> <p>passend für: V113 PR_Eintopfschale 1,20 ltr. V635 PL_Eintopfschale schwappsicher 21 cm</p>	1	PP	83°C







ARTIKELVERZEICHNIS

ARTIKELNUMMER	VE	Material	Temperatur bis
	1	PP	83°C
<p>0260 Deckel FN_PORTKA_035_004 dunkelbraun</p> <p>passend für: V140 PR_Portionskanne 0,35 ltr. V240 IM_Portionskanne 0,25 ltr. V511 PR_Portionskanne 0,27 ltr. V787 PR_Portionskanne 0,31 ltr.</p>			
	1	PP	83°C
<p>0270 Deckel FK_SUSCHA_031_005 grau</p> <p>passend für: V151 PR_Suppenschale 0,31 ltr. V251 IM_Salatschale 0,31 ltr. V293 IM_Salatschale rund 10 cm V351 PL_Suppenschale 0,31 ltr. V620 PL_Suppenschale V648 PL_Suppenschale 0,31 ltr.</p>			
	1	PP	83°C
<p>0280 Deckel FK_SUSCHA_040_006 grau</p> <p>passend für: V101 PR_Suppenschale_0,40 ltr. mit Griff V108 PR_Salatschale rund 12 cm V161 PR_Suppenschale 0,40 ltr. V190 PR_Salatschale rund 12 cm V201 IM_Suppenschale 0,40 ltr. mit Griff V301 PL_Suppenschale 0,40 ltr. mit Griff V308 PL_Salatschale rund 12 cm V531 PR_Suppenschale schwappsicher 0,45 ltr. V631 PL_Suppenschale schwappsicher 0,45 ltr.</p>			
	1	PP	83°C
<p>0290 Deckel FK_SUSCHA_050_008 grau</p> <p>passend für: V103 PR_Suppenschale 0,50 ltr. mit Griff V106 MA_Salatschale rund 13 cm V202 IM_Suppenschale 0,45 ltr. mit Griff V203 IM_Suppenschale 0,50 ltr. mit Griff V206 IM_Salatschale rund 13 cm V609 PL_Eintopfschale 0,50 ltr. V610 PL_Eintopfschale 0,40 ltr.</p>			
	1	PP	83°C
<p>0300 Deckel FK_SUSCHA_090_010 grau</p> <p>passend für: V104 PR_Suppenschale 0,90 ltr. mit Griff V110 PR_Eintopfschale 0,95 ltr. V204 IM_Suppenschale 0,90 ltr. mit Griff V210 IM_Eintopfschale 0,90 ltr. V646 PL_Eintopfschale schwappsicher 17,5 cm</p>			
	1	PP	83°C
<p>0310 Deckel FK_EINTOPF1,1_012 grau</p> <p>passend für: V112 PR_Eintopfschale 1,1 ltr. V212 IM_Eintopfschale 1,1 ltr. V312 PL_Eintopfschale 1,1 ltr. V591 PR_Eintopf 1,0 ltr.</p>			





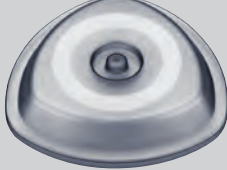
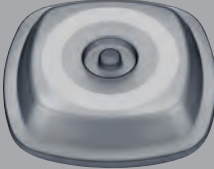

KUNSTSTOFFDECKEL

ARTIKELNUMMER	VE	Material	Temperatur bis
	1	PP	83°C
<p>0320 Deckel FK_EINTOPF1,2_013 grau</p> <p>passend für: V113 PR_Eintopfschale 1,2 ltr. V635 PL_Eintopfschale schwappsicher 21 cm</p>			
	1	PP	83°C
<p>0330 Deckel FK_PORTKA_035_004 grau</p> <p>passend für: V140 PR_Portionskanne_0,35 ltr. V240 IM_Portionskanne_0,25 ltr. V511 PR_Portionskanne_0,27 ltr. V787 PR_Portionskanne_0,31 ltr.</p>			
	1	PP	83°C
<p>0340 Deckel FK_BECHER_002 grau</p> <p>passend für: V142 PR_Becher mit Henkel 0,32 ltr. V152 PR_Becher mit Henkel 0,25 ltr. V153 PR_Becher mit Henkel 0,30 ltr.</p>			
	1	PP	83°C
<p>0360 Deckel FL_SUSCHA_040_006 flieder</p> <p>passend für: V101 PR_Suppenschale_0,40 ltr. mit Griff V108 PR_Salatschale rund 12 cm V161 PR_Suppenschale 0,40 ltr. V190 PR_Salatschale rund 12 cm V201 IM_Suppenschale 0,40 ltr. mit Griff V301 PL_Suppenschale 0,40 ltr. mit Griff V308 PL_Salatschale rund 12 cm V531 PR_Suppenschale schwappsicher 0,45 ltr. V631 PL_Suppenschale schwappsicher 0,45 ltr.</p>			
	1	PP	83°C
<p>0370 Deckel FL_SUSCHA_050_008 flieder</p> <p>passend für: V103 PR_Suppenschale 0,50 ltr. mit Griff V106 MA_Salatschale rund 13 cm V202 IM_Suppenschale 0,45 ltr. mit Griff V203 IM_Suppenschale 0,50 ltr. mit Griff V206 IM_Salatschale rund 13 cm V609 PL_Eintopfschale 0,50 ltr. V610 PL_Eintopfschale 0,40 ltr.</p>			
	1	PP	83°C
<p>0380 Deckel FL_SUSCHA_090_010 flieder</p> <p>passend für: V104 PR_Suppenschale 0,90 ltr. mit Griff V110 PR_Eintopfschale 0,95 ltr. V204 IM_Suppenschale 0,90 ltr. mit Griff V210 IM_Eintopfschale 0,90 ltr. V646 PL_Eintopfschale schwappsicher 17,5 cm</p>			

ARTIKELVERZEICHNIS





ARTIKELNUMMER	VE	Material	Temperatur bis	
	0390 Deckel FL_EINTOPF1,1_012 flieder passend für: V112 PR_Eintopfschale 1,10 ltr. V212 IM_Eintopfschale 1,10 ltr. V312 PL_Eintopfschale 1,10 ltr. V591 PR_Eintopf 1,00 ltr.	1	PP	83°C
	0400 Deckel FL_EINTOPF1,2_013 flieder passend für: V113 PR_Eintopfschale 1,20 ltr. V635 PL_Eintopfschale schwappsicher 21 cm	1	PP	83°C
	0410 FL_PORTKA_035_004 flieder passend für: V140 PR_Portionskanne 0,35 ltr. V240 IM_Portionskanne 0,25 ltr. V511 PR_Portionskanne 0,27 ltr. V787 PR_Portionskanne 0,31 ltr.	1	PP	83°C
	0420 Deckel AA_SUSCHA_031_003 grau-transparent passend für: V139 PR_Suppenschale 0,31 ltr. mit Griff V187 PR_Suppenschale 0,30 ltr. mit Hkl. V339 PL_Suppenschale 0,31 ltr. V367 PL_Suppenschale 0,26 ltr. mit Hkl. V387 PL_Suppenschale 0,30 ltr. mit Hkl. V397 PL_Suppenschale 0,30 ltr. mit 2 Hkl. V603 PL_Suppenschale 0,30 ltr. mit Griff	1	PSU	170°C
	0430 Deckel AA_TELLER_3EC_034 grau-transparent passend für: V780 PR_Teller 3-eckig 23,8 cm	1	PSU	170°C
	0440 Deckel AA_TELLER_4EC_025 grau-transparent passend für: V633 PL_Teller 4-eckig 24 cm V634 PL_Teller 4-eckig 2-tlg. 24 cm V781 PR_Teller 4-eckig 24 cm V788 PR_Teller 4-eckig 2-tlg. 24 cm V789 PR_Teller 4-eckig 2-tlg. 24 cm	1	PSU	170°C
	0450 Deckel AA_DESSERT_EC_024 grau-transparent passend für: V783 PR_Dessertschale 4-eckig 15 cm	1	PSU	170°C
	0460 Deckel AA_SUSCHA_RD_009 grau-transparent passend für: V105 PR_Suppenschale 0,45 ltr. V205 IM_Suppenschale 0,45 ltr. V611 PL_Suppenschale 0,40 ltr. V790 PR_Suppenschale 0,53 ltr.	1	PSU	170°C

KUNSTSTOFFDECKEL





ARTIKELNUMMER	VE	Material	Temperatur bis	
	<p>0490 Deckel AA_PLATTE2020_023 grau-transparent</p> <p>passend für: V125 PR_Platte eckig 1-tlg. 20 x 20 cm V325 PL_Platte eckig 1-tlg. 20 x 20 cm</p>	1	PSU	170°C
	<p>0510 EE_SALAT_HOCH_021 glasklar</p> <p>passend für: V135 PR_Salatschale eckig 12 x 12 cm V232 IM_Salatschale eckig 12 x 12 cm</p>	1	PC	110°C
	<p>0520 Deckel EE_SCHA_1309_028 glasklar</p> <p>passend für: V129 PR_Schale eckig 13 x 9 cm</p>	1	PC	110°C
	<p>0530 Deckel AA_TELLER_200_014 grau-transparent</p> <p>passend für: V509 PR_Teller flach 19,7 cm V770 PR_Teller flach 20,5 cm</p>	1	PSU	170°C
	<p>0540 Deckel AA_EINTOPF1,1_011 grau-transparent</p> <p>passend für: V112 PR_Eintopfschale 1,10 ltr. V212 IM_Eintopfschale 1,10 ltr. V312 PL_Eintopfschale 1,10 ltr.</p>	1	PSU	170°C
	<p>0550 Deckel AA_PORTKA_035_004 grau-transparent</p> <p>passend für: V140 PR_Portionskanne 0,35 ltr. V240 IM_Portionskanne 0,25 ltr. V511 PR_Portionskanne 0,27 ltr. V787 PR_Portionskanne 0,31 ltr.</p>	1	PSU	170°C
	<p>0560 Deckel AA_TELLER_255_016 grau-transparent</p> <p>passend für: V114 PR_Teller halbtief 25,5 cm V115 PR_Teller flach 25,5 cm V119 PR_Platte rund 3-tlg. 25,5 cm V120 PR_Platte rund 3-tlg. 25,5 cm Coup V138 PR_Platte rund 3-tlg. 26 cm V164 PR_Teller halbtief 26 cm Coup V215 IM_Teller flach 25,5 cm V219 IM_Platte rund 3-tlg. 25,5 cm V276 IM_Teller halbtief 25,5 cm V295 IM_Platte rund 2-tlg. 25,5 cm V315 PL_Teller flach 25,5 cm V316 PL_Teller halbtief 25,5 cm V319 PL_Platte rund 3-tlg. 25,5 cm V320 PL_Platte rund 3-tlg. 25,5 cm Coup V356 PL_Platte rund 2-tlg. 25,5 cm Coup</p>	1	PSU	170°C

ARTIKELNUMMER	VE	Material	Temperatur bis	
	0570 Deckel AA_TELLER_230_015 grau-transparent	1	PSU	170°C
<p>passend für:</p> <ul style="list-style-type: none"> V147 PR_Teller rund 2-tlg. 23 cm V150 PR_Teller flach 23 cm V165 PR_Eintopfeller 23 cm V174 PR_Teller flach 22,5 cm V186 PR_Teller rund 3-tlg. 23 cm V347 PL_Teller rund 2-tlg. 23 cm V350 PL_Teller flach 23 cm V365 PL_Eintopfeller 23 cm V366 PL_Teller tief 23 cm V386 PL_Teller rund 3-tlg. 23 cm V389 PR_Teller rund 2-tlg. 23 cm V647 PL_Teller rund 23 cm V730 PR_Teller flach 23 cm V731 PR_Teller rund 2-tlg. 23 cm V765 PL_Eintopfeller 23 cm V782 PR_Teller rund 23 cm 				
	0580 Deckel AA_SALAT_EC12_019 grau-transparent	1	PSU	170°C
<p>passend für:</p> <ul style="list-style-type: none"> V134 PR_Salatschale eckig 10 x 10 cm V172 PR_Schale eckig 10 x 10 cm V334 PL_Salatschale eckig 10 x 10 cm 				
	0590 Deckel EE_SALAT_EC_K_017 glasklar	1	PC	110°C
<p>passend für:</p> <ul style="list-style-type: none"> V133 PR_Salatschale eckig 11 x 11 cm 				
	0600 EE_SALAT_EC_G_018 glasklar	1	PC	110°C
<p>passend für:</p> <ul style="list-style-type: none"> V135 PR_Salatschale eckig 12 x 12 cm V232 IM_Salatschale eckig 12 x 12 cm 				
	0610 Deckel AA_SAUCIERE_001 grau-transparent	1	PSU	170°C
<p>passend für:</p> <ul style="list-style-type: none"> V368 PL_Sauciere 0,10 ltr. V380 PL_Sauciere 0,19 ltr. mit Henkel 				
	0630 Deckel AA_SALAT_2010_032 grau-transparent	1	PSU	170°C
<p>passend für:</p> <ul style="list-style-type: none"> V171 PR_Schale eckig 20 x 10 cm V189 PR_Schale eckig 3-tlg. 20 x 10 cm V192 PR_Salatschale eckig 20 x 10 cm V392 PL_Salatschale eckig 20 x 10 cm 				
	0640 Deckel AA_SALAT_EC15_020 grau-transparent	1	PSU	170°C
<p>passend für:</p> <ul style="list-style-type: none"> V135 PR_Salatschale eckig 12 x 12 cm V232 IM_Salatschale eckig 12 x 12 cm V514 PR_Salatschale eckig 12 x 12 cm 				
	0760 Deckel GR_PLATTE2717_033 warm grey	1	PBT	170°C
<p>passend für:</p> <ul style="list-style-type: none"> V502 PL_Platte eckig 1-tlg. 27 x 17 cm V503 PL_Platte eckig 2-tlg. 27 x 17 cm 				

KUNSTSTOFFDECKEL

ARTIKELNUMMER	VE	Material	Temperatur bis	
	<p>0790 Deckel GR_SUSCHA_040_006 warm grey</p> <p>passend für: V101 PR_Suppschale_0,40 ltr. mit Griff V108 PR_Salatschale rund 12 cm V161 PR_Suppschale 0,40 ltr. V190 PR_Salatschale rund 12 cm V201 IM_Suppschale 0,40 ltr. mit Griff V301 PL_Suppschale 0,40 ltr. mit Griff V308 PL_Salatschale rund 12 cm V531 PR_Suppschale schwappsicher 0,45 ltr. V631 PL_Suppschale schwappsicher 0,45 ltr.</p>	1	PBT	170°C
	<p>0800 Deckel GR_SUSCHA_050_008 warm grey</p> <p>passend für: V103 PR_Suppschale 0,50 ltr. mit Griff V106 MA_Salatschale rund 13 cm V202 IM_Suppschale 0,45 ltr. mit Griff V203 IM_Suppschale 0,50 ltr. mit Griff V206 IM_Salatschale rund 13 cm V609 PL_Eintopfschale 0,50 ltr. V610 PL_Eintopfschale 0,40 ltr.</p>	1	PBT	170°C
	<p>0810 Deckel GR_EINTOPF1,1_012 warm grey</p> <p>passend für: V112 PR_Eintopfschale 1,10 ltr. V212 IM_Eintopfschale 1,10 ltr. V312 PL_Eintopfschale 1,10 ltr. V591 PR_Eintopf 1,00 ltr.</p>	1	PBT	170°C
	<p>0820 Deckel AA_DESSERT_3EC036 grau-transparent</p> <p>passend für: Dessertschale 3-eckig 15 cm Sketch</p>	1	PSU	170°C
	<p>0830 Deckel GR_TELLER_230_015 warm grey</p> <p>passend für: V147 PR_Teller rund 2-tlg. 23 cm V150 PR_Teller flach 23 cm V165 PR_Eintopfteller 23 cm V174 PR_Teller flach 22,5 cm V186 PR_Teller rund 3-tlg. 23 cm V347 PL_Teller rund 2-tlg. 23 cm V350 PL_Teller flach 23 cm V365 PL_Eintopfteller 23 cm V366 PL_Teller tief 23 cm V386 PL_Teller rund 3-tlg. 23 cm V389 PR_Teller rund 2-tlg. 23 cm V647 PL_Teller rund 23 cm V730 PR_Teller flach 23 cm V731 PR_Teller rund 2-tlg. 23 cm V765 PL_Eintopfteller 23 cm V782 PR_Teller rund 23 cm</p>	1	PBT	170°C

ARTIKELVERZEICHNIS

ARTIKELNUMMER	VE	Material	Temperatur bis	
	0840 Deckel HK_SUSCHA_031_037 grau passend für: V151 PR_Suppenschale 0,31 ltr. V251 IM_Suppenschale 0,31 ltr. V293 IM_Salatschale rund 10 cm V351 PL_Suppenschale 0,31 ltr. V620 PL_Suppenschale V648 PL_Suppenschale 0,31 ltr.	1	TPE-S	140°C
	0860 Deckel HK_SUSCHA_050_039 grau passend für: V106 MA_Salatschale rund 13 cm V202 IM_Suppenschale 0,45 ltr. mit Griff V203 IM_Suppenschale 0,50 ltr. mit Griff V206 IM_Salatschale rund 13 cm V609 PL_Eintopfschale 0,50 ltr. V610 PL_Eintopfschale 0,40 ltr. V611 PL_Suppenschale 0,40 ltr. V790 PR_Suppenschale 0,53 ltr.	1	TPE-S	140°C
	0870 Deckel IK_TELLER_255_040 grau passend für: V115 PR_Teller flach 25,5 cm V120 PR_Platte rund 3-tlg. 25,5 cm Coup V138 PR_Platte rund 3-tlg. 26 cm V162 PR_Teller flach 26 cm Coup V164 PR_Teller halbtief 26 cm Coup V215 IM_Teller flach 25,5 cm V276 IM_Teller halbtief 25,5 cm V315 PL_Teller flach 25,5 cm V316 PL_Teller halbtief 25,5 cm	1	PBT	160°C
	0890 Deckel EE_TELLER_255_040 glasklar passend für: V115 PR_Teller flach 25,5 cm V120 PR_Platte rund 3-tlg. 25,5 cm Coup V138 PR_Platte rund 3-tlg. 26 cm V162 PR_Teller flach 26 cm Coup V164 PR_Teller halbtief 26 cm Coup V215 IM_Teller flach 25,5 cm V219 IM_Platte rund 3-tlg. 25,5 cm V276 IM_Teller halbtief 25,5 cm V315 PL_Teller flach 25,5 cm V316 PL_Teller halbtief 25,5 cm	1	PC	110°C
	0990 Deckel FK_SUSCHA_128_044 grau passend für: V170 PR_Suppenschale 0,45 ltr. V548 PR_Suppenschale schwappsicher 0,45 ltr. V549 PR_Suppenschale 0,45 ltr.	1	PP	110°C

KUNSTSTOFFDECKEL

	ARTIKELNUMMER	VE	Material	Temperatur bis
	1000 Deckel IK_TELLER_230_045 grau passend für: V165 PR_Eintopfeller 23 cm V186 PR_Teller rund 3-tlg. 23 cm V347 PL_Teller rund 2-tlg. 23 cm V350 PL_Teller flach 23 cm V366 PL_Teller tief 23 cm V386 PL_Teller rund 3-tlg. 23 cm V647 PL_Teller rund 23 cm V730 PR_Teller flach 23 cm V731 PR_Teller rund 2-tlg. 23 cm V782 PR_Teller rund 23 cm	1	PBT	160°C
	1020 Deckel KE_HALBMOND_046 glasklar passend für: V181 PR_Halbmondschale	1	PET	65°C
	1040 Deckel GR_SUSCHALE_031 warm grey passend für: V139 PR_Suppenschale 0,31 ltr. mit Griff V187 PR_Suppenschale 0,30 ltr. mit Hkl. V339 PL_Suppenschale 0,31 ltr. V367 PL_Suppenschale 0,26 ltr. mit Hkl. V387 PL_Suppenschale 0,30 ltr. mit Hkl. V397 PL_Suppenschale 0,30 ltr. mit 2 Hkl. V603 PL_Suppenschale 0,30 ltr. mit Griff	1	PBT	170°C
	1050 Deckel KE_SCHALE1185_047 glasklar passend für: V130 PR_Schale eckig 11x8,5 cm V330 PL_Schale eckig 11x8,5 cm V560 PR_Schale eckig 11x8 cm	1	PET	65°C
	1060 Deckel KE_SCHALE1117_048 glasklar passend für: V131 PR_Schale eckig 17,5x11 cm V182 PR_Platte eckig 1-tlg. 17,5x11 cm V622 PL_Schale 17,5x11 cm hoch	1	PET	65°C
	1070 Deckel FV_Platte_1611_030 milchig passend für: V128 PR_Platte eckig 1-tlg. 16x11 cm V556 PR_Platte eckig 1-tlg. 16x11 cm	1	PP	88°C
	1090 Deckel DD_Teller_4ec_025 transparent passend für: V633 PL_Teller 4-eckig 24 cm V634 PL_Teller 4-eckig 2-tlg. 24 cm V781 PR_Teller 4-eckig 24 cm V788 PR_Teller 4-eckig 2-tlg. 24 cm V789 PR_Teller 4-eckig 2-tlg. 24 cm	1	PC	100°C

ARTIKELVERZEICHNIS

ARTIKELNUMMER	VE	Material	Temperatur bis	
	<p>1120 Deckel FV_TELLER_255_049 glasklar-milchig</p> <p>passend für: V114 PR_Teller halbtief 25,5 cm V115 PR_Teller flach 25,5 cm V119 PR_Platte rund 3-tlg. 25,5 cm V215 IM_Teller flach 25,5 cm V295 IM_Platte rund 2-tlg. 25,5 cm V315 PL_Teller flach 25,5 cm V316 PL_Teller halbtief 25,5 cm V319 PL_Platte rund 3-tlg. 25,5 cm V320 PL_Platte rund 3-tlg. 25,5 cm Coup V356 PL_Platte rund 2-tlg. 25,5 cm Coup</p>	1	PP	88°C
	<p>1130 Deckel FV_SUSCHA_050_007 milchig</p> <p>passend für: V103 PR_Suppenschale 0,50 ltr. mit Griff V106 MA_Salatschale rund 13 cm V202 IM_Suppenschale 0,45 ltr. mit Griff V203 IM_Suppenschale 0,50 ltr. mit Griff V206 IM_Salatschale rund 13 cm V609 PL_Eintopfschale 0,50 ltr. V610 PL_Eintopfschale 0,40 ltr.</p>	1	PP	88°C
	<p>1170 Deckel FV_Platte1818_053 milchig</p> <p>passend für: V126 PR_Platte eckig 1-tlg. 18x18 cm</p>	1	PP	67°C
	<p>1210 Deckel FK_Schalehoch_057 grau</p> <p>passend für: V621 PL_Schale 11x8,5 cm hoch</p>	1	PP	110°C
	<p>1220 Deckel FV_TELLER_230_045 glasklar-milchig</p> <p>passend für: V147 PR_Teller rund 2-tlg. 23 cm V150 PR_Teller flach 23 cm V165 PR_Eintopfeller 23 cm V174 PR_Teller flach 22,5 cm V186 PR_Teller rund 3-tlg. 23 cm V347 PL_Teller rund 2-tlg. 23 cm V350 PL_Teller flach 23 cm V365 PL_Eintopfeller 23 cm V366 PL_Teller tief 23 cm V386 PL_Teller rund 3-tlg. 23 cm V389 PL_Teller rund 2-tlg. 23 cm V647 PL_Teller rund 23 cm V730 PR_Teller flach 23 cm V731 PR_Teller rund 2-tlg. 23 cm V765 PL_Eintopfeller 23 cm V782 PR_Teller rund 23 cm</p>	1	PP	88°C







KUNSTSTOFFDECKEL

ARTIKELNUMMER	VE	Material	Temperatur bis	
	<p>1250 Deckel FV_TELLER_200_014 glasklar-milchig</p> <p>passend für: V369 PL_Teller tief 19,5 cm Coup V509 PR_Teller flach 19,7 cm V770 PR_Teller flach 20,5 cm</p>	1	PP	88°C
	<p>1260 Deckel FV_TELLER_190_059 glasklar-milchig</p>	1	PP	88°C
	<p>1290 Deckel FV_SCHALE HOCH_057 glasklar-milchig</p> <p>passend für: V621 PL_Schale hoch 11 x 8,5 cm</p>	1	PP	88°C
	<p>1300 Deckel AA_TE_HOCH_230_061 grau-transparent</p> <p>passend für: V147 PR_Teller rund 2-tlg. 23 cm V150 PR_Teller flach 23 cm V186 PR_Teller rund 3-tlg. 23 cm V347 PL_Teller rund 2-tlg. 23 cm V350 PL_Teller flach 23 cm V366 PL_Teller tief 23 cm V386 PL_Teller rund 3-tlg. 23 cm V389 PL_Teller rund 2-tlg. 23 cm V647 PL_Teller rund 23 cm V730 PR_Teller flach 23 cm V731 PR_Teller rund 2-tlg. 23 cm V782 PR_Teller rund 23 cm</p>	1	PSU	170°C
	<p>1310 Deckel GR_TELLER_255_019 warm grey</p> <p>passend für: V114 PR_Teller halbtief 25,5 cm V115 PR_Teller flach 25,5 cm V119 PR_Platte rund 3-tlg. 25,5 cm V215 IM_Teller flach 25,5 cm V295 IM_Platte rund 2-tlg. 25,5 cm V315 PL_Teller flach 25,5 cm V316 PL_Teller halbtief 25,5 cm V319 PL_Platte rund 3-tlg. 25,5 cm V320 PL_Platte rund 3-tlg. 25,5 cm Coup V356 PL_Platte rund 2-tlg. 25,5 cm Coup</p>	1	PBT	170°C
	<p>1320 Deckel GR_Eintopf1,2_013 warm grey</p> <p>passend für: V113 PR_Eintopfschale 1,20 ltr. V635 PL_Eintopfschale schwappsicher 21 cm</p>	1	PBT	170°C

ARTIKELVERZEICHNIS

ARTIKELNUMMER	VE	Material	Temperatur bis	
	<p>1340 Deckel FV_Schale1408_029 glasklar-milchig</p> <p>passend für: V505 PR_Schale eckig 14 x 8 cm</p>	1	PP	88°C
	<p>1350 Deckel FV_Schale1108_062 glasklar-milchig</p> <p>passend für: V551 PR_Schale eckig 11 x 8 cm V562 PR_Schale eckig 11 x 8 cm hoch</p>	1	PP	88°C
	<p>1360 Deckel FV_Schale1611_063 glasklar-milchig</p> <p>passend für: V553 PR_Schale eckig 16 x 11 cm V556 PR_Platte eckig 1-tlg. 16 x 11 cm</p>	1	PP	88°C
	<p>1370 Deckel FV_Teller2216_064 glasklar-milchig</p> <p>passend für: V554 PR_Platte eckig 1-tlg. 22 x 16 cm V555 PR_Teller eckig 1-tlg. 22 x 16 cm V557 PR_Schale eckig 22 x 16 cm</p>	1	PP	88°C
	<p>1410 Deckel FY_TELLER_3EC_034 grau-transparent</p> <p>passend für: V780 PR_Teller 3-eckig 23,8 cm</p>	1	PP	80°C
	<p>1420 Deckel FY_SUSCHA_RD_009 grau-transparent</p> <p>passend für: V105 PR_Suppenschale 0,45 ltr. V205 IM_Suppenschale 0,45 ltr. V609 PL_Eintopfschale 0,50 ltr. V611 PL_Suppenschale 0,40 ltr. V790 PR_Suppenschale 0,53 ltr.</p>	1	PP	80°C
	<p>1430 Deckel FY_DESSERT_EC_024 grau-transparent</p> <p>passend für: V783 PR_Dessertschale 4-eckig 15 cm</p>	1	PP	80°C

KUNSTSTOFFDECKEL



ARTIKELNUMMER	VE	Material	Temperatur bis
	1	PP	80°C
<p>1440 Deckel FY_DESSERT_3EC_036</p> <p>passend für: Sketch Dessertschale 3-eckig 15 cm</p>			
	1	PP	80°C
<p>1450 Deckel FY_TELLER_255_016 grau-transparent</p> <p>passend für: V114 PR_Teller halbtief 25,5 cm V115 PR_Teller flach 25,5 cm V119 PR_Platte rund 3-tlg. 25,5 cm V215 IM_Teller flach 25,5 cm V295 IM_Platte rund 2-tlg. 25,5 cm V315 PL_Teller flach 25,5 cm V316 PL_Teller halbtief 25,5 cm V319 PL_Platte rund 3-tlg. 25,5 cm V320 PL_Platte rund 3-tlg. 25,5 cm Coup V356 PL_Platte rund 2-tlg. 25,5 cm Coup</p>			
	1	PP	80°C
<p>1460 Deckel FY_SAUCIERE_001 grau-transparent</p> <p>passend für: V368 PL_Sauciere 0,10 ltr. V380 PL_Sauciere 0,09 ltr. mit Henkel</p>			
	1	PBT	170°C
<p>1470 Deckel GR_TE_HOCH_230_067 warm grey</p> <p>passend für: V150 PR_Teller flach 23 cm V174 PR_Teller flach 22,5 cm V350 PL_Teller flach 23 cm V366 PL_Teller tief 23 cm V386 PL_Teller rund 3-tlg. 23 cm V389 PL_Teller rund 2-tlg. 23 cm V730 PR_Teller flach 23 cm V731 PR_Teller rund 2-tlg. 23 cm</p>			
	1	PBT	170°C
<p>1480 Deckel GR_Eintopf1,0_010 warm grey</p> <p>passend für: V104 PR_Suppenschale 0,90 ltr. mit Griff V204 IM_Suppenschale 0,90 ltr. mit Griff V110 PR_Eintopfschale 0,95 ltr. V210 IM_Eintopfschale 0,90 ltr. V646 PL_Eintopfschale schwappsicher 17,5 cm</p>			
	1	PSU	170°C
<p>1490 Deckel AA_SUSCHASCHW_068 grau-transparent</p> <p>passend für: V515 PR_Suppenschale 0,40 ltr. mit Griff V531 PR_Suppenschale schwappsicher 0,45 ltr. V631 PL_Suppenschale schwappsicher 0,45 ltr.</p>			

ARTIKELNUMMER	VE	Material	Temperatur bis	
	<p>1510 Deckel FY_TELLER_230_015 grau-transparent</p> <p>passend für:</p> <p>V147 PR_Teller rund 2-tlg. 23 cm V150 PR_Teller flach 23 cm V165 PR_Eintopfeller 23 cm V174 PR_Teller flach 22,5 cm V186 PR_Teller rund 3-tlg. 23 cm V347 PL_Teller rund 2-tlg. 23 cm V350 PL_Teller flach 23 cm V365 PL_Eintopfeller 23 cm V366 PL_Teller tief 23 cm V386 PL_Teller rund 3-tlg. 23 cm V389 PL_Teller rund 2-tlg. 23 cm V647 PL_Teller rund 23 cm V730 PR_Teller flach 23 cm V731 PR_Teller rund 2-tlg. 23 cm V765 PL_Eintopfeller 23 cm V782 PR_Teller rund 23 cm</p>	1	PP	80°C
	<p>1520 Deckel FV_Schale1108_071 glasklar-milchig</p> <p>passend für:</p> <p>V551 PR_Schale eckig 11 x 8 cm V562 PR_Schale eckig 11 x 8 cm hoch</p>	1	PP	88°C
	<p>1530 Deckel FV_Pla1611_ho_070 glasklar-milchig</p> <p>passend für:</p> <p>V553 PR_Schale eckig 16 x11 cm V556 PR_Platte eckig 1-tlg. 16 x 11 cm</p>	1	PP	88°C
	<p>1540 Deckel FY_SALAT_EC15_020 grau-transparent</p> <p>passend für:</p> <p>V514 PR_Salatschale eckig 12 x 12 cm</p>	1	PP	80°C
	<p>1550 Deckel FY_EINTOPF1,1_011 grau-transparent</p> <p>passende für:</p> <p>V112 PR_Eintopfschale 1,10 ltr. V212 IM_Eintopfschale 1,10 ltr. V312 PL_Eintopfschale 1,10 ltr. V591 PR_Eintopf 1,00 ltr.</p>	1	PP	80°C
	<p>1560 Deckel FY_SUSCHA_050_007 grau-transparent</p> <p>passend für:</p> <p>V103 PR_Suppenschale 0,50 ltr. mit Griff V106 MA_Salatschale rund 13 cm V202 IM_Suppenschale 0,45 ltr. mit Griff V203 IM_Suppenschale 0,50 ltr. mit Griff V206 IM_Salatschale rund 13 cm V609 PL_Eintopfschale 0,50 ltr. V610 PL_Eintopfschale 0,40 ltr.</p>	1	PP	80°C

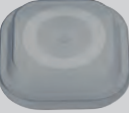

KUNSTSTOFFDECKEL

ARTIKELNUMMER	VE	Material	Temperatur bis
	1	PC	80°C
<p>1570 Deckel EE_Schale1108_071 glasklar</p> <p>passend für: V551 PR_Schale eckig 11 x 8 cm V560 PR_Schale eckig 11 x 8 cm V562 PR_Schale eckig 11 x 8 cm hoch</p>			
	1	PC	80°C
<p>1580 Deckel EE_Pla1611_ho_070 glasklar</p> <p>passend für: V553 PR_Schale eckig 16 x 11 cm V556 PR_Platte eckig 1-tlg. 16 x 11 cm</p>			
	1	PBT	170°C
<p>1600 Deckel GR_TE_HOCH_255_016 warm grey</p> <p>passend für: V114 PR_Teller halbtief 25,5 cm V115 PR_Teller flach 25,5 cm V119 PR_Platte rund 3-tlg. 25,5 cm V215 IM_Teller flach 25,5 cm V219 IM_Platte rund 3-tlg. 25,5 cm V295 IM_Platte rund 2-tlg. 25,5 cm V315 PL_Teller flach 25,5 cm V316 PL_Teller halbtief 25,5 cm V319 PL_Platte rund 3-tlg. 25,5 cm V320 PL_Platte rund 3-tlg. 25,5 cm Coup V356 PL_Platte rund 2-tlg. 25,5 cm Coup</p>			
	1	PP	88°C
<p>1610 Deckel FV_Schale_1111_072 glasklar-milchig</p> <p>passend für: V133 PR_Salatschale eckig 11 x 11 cm V564 PR_Schale eckig 11 x 11 cm hoch</p>			
	1	PC	80°C
<p>1620 Deckel EE_Salat_1111_072 glasklar</p> <p>passende für: V133 PR_Salatschale eckig 11 x 11 cm V564 PR_Schale eckig 11 x 11 cm hoch</p>			
	1	PBT	170°C
<p>1630 Deckel GR_TELLER_4EC_025 warm grey</p> <p>passend für: V633 PL_Teller 4-eckig 24 cm V634 PL_Teller 4-eckig 2-tlg. 24 cm V781 PR_Teller 4-eckig 24 cm V788 PR_Teller 4-eckig 2-tlg. 24 cm V789 PR_Teller 4-eckig 2-tlg. 24 cm</p>			

ARTIKELVERZEICHNIS

ARTIKELNUMMER	VE	Material	Temperatur bis	
	<p>1670 Deckel MA_TELLER_255_016 grau-transparent</p> <p>passend für:</p> <ul style="list-style-type: none"> V114 PR_Teller halbtief 25,5 cm V115 PR_Teller flach 25,5 cm V119 PR_Platte rund 3-tlg. 25,5 cm V164 PR_Teller halbtief 26 cm Coup V215 IM_Teller flach 25,5 cm V219 IM_Platte rund 3-tlg. 25,5 cm V260 IM_Platte rund 3-tlg. 3/3 25,5 cm V276 IM_Teller halbtief 25,5 cm V295 IM_Platte rund 2-tlg. 25,5 cm V315 PL_Teller flach 25,5 cm V316 PL_Teller halbtief 25,5 cm V319 PL_Platte rund 3-tlg. 25,5 cm V320 PL_Platte rund 3-tlg. 25,5 cm Coup V356 PL_Platte rund 2-tlg. 25,5 cm Coup 	1	PA	140°C
	<p>1690 Deckel FY_Salat_EC12_019 grau-transparent</p> <p>passend für:</p> <ul style="list-style-type: none"> V134 PR_Salatschale eckig 10 x 10 cm V172 PR_Schale eckig 10 x 10 cm V334 PL_Salatschale eckig 10 x 10 cm 	1	PP	80°C
	<p>1710 Deckel MA_TELLER_230_015 grau-transparent</p> <p>passend für:</p> <ul style="list-style-type: none"> V147 PR_Teller rund 2-tlg. 23 cm V150 PR_Teller flach 23 cm V174 PR_Teller flach 22,5 cm V186 PR_Teller rund 3-tlg. 23 cm V347 PL_Teller rund 2-tlg. 23 cm V350 PL_Teller flach 23 cm V366 PL_Teller tief 23 cm V386 PL_Teller rund 3-tlg. 23 cm V389 PL_Teller rund 2-tlg. 23 cm V647 PL_Teller rund 23 cm V730 PR_Teller flach 23 cm V731 PR_Teller rund 2-tlg. 23 cm V782 PR_Teller rund 23 cm 	1	PA	140°C
	<p>1750 Deckel HN_PORTKA_035_077 dunkelbraun</p> <p>passend für:</p> <ul style="list-style-type: none"> V511 PR_Portionskanne 0,27 ltr. 	1	TPE-S	140°C
	<p>1770 Deckel HO_PORTKA_035_077 grün</p> <p>passend für:</p> <ul style="list-style-type: none"> V511 PR_Portionskanne 0,27 ltr. 	1	TPE-S	140°C

KUNSTSTOFFDECKEL

ARTIKELNUMMER	VE	Material	Temperatur bis	
	<p>1780 Deckel HK_PORTKA_035_077 grau</p> <p>passend für: V511 PR_Portionskanne 0,27 ltr.</p>	1	TPE-S	140°C
	<p>1810 Deckel GR_SUSCHA_031_005 warm grey</p> <p>passend für: V151 PR_Suppenschale 0,31 ltr. V251 IM_Suppenschale 0,31 ltr. V293 IM_Salatschale rund 10 cm V351 PL_Suppenschale 0,31 ltr. V620 PL_Suppenschale V648 PL_Suppenschale 0,31 ltr.</p>	1	PBT	170°C







Seltmann
Weiden

SYSTEM

Ihr Fachhändler / Your dealer:

Rudolf **TANNER** Handelsges.m.b.H.

A-2320 Schwechat, Haydnstraße 26

Tel.: +43 664 33 50 500 +43 664 45 61 015

E-Mail: office@rtanner.at,

Homepage: www.rtanner.at

